

Load Rating Chart

Model TC65131



© Manitex 2000

NOTE: Additional copies of this Load Rating Chart can be purchased from your Manitex Distributor. When ordering, use the part number shown in the bottom left hand corner of this page.

LMI OPERATING CODES

CODE	CRANE CONFIGURATION	OUTRIGGER CONFIGURATION	AREA OF OPERATION	CWT (LBS)	PAGE
1	MAIN BOOM	100% EXTENDED	FULL 360°	10000	11
2	MAIN BOOM	100% EXTENDED	FULL 360°	8750	12
3	MAIN BOOM	100% EXTENDED	FULL 360°	7500	13
4	MAIN BOOM	100% EXTENDED	FULL 360°	6250	14
5	MAIN BOOM	100% EXTENDED	FULL 360°	5000	15
6	MAIN BOOM	100% EXTENDED	FULL 360°	3750	16
7	MAIN BOOM	100% EXTENDED	FULL 360°	2500	17
8	MAIN BOOM	100% EXTENDED	FULL 360°	1250	18
9	MAIN BOOM	100% EXTENDED	FULL 360°	0	19
10	MAIN BOOM	100% EXTENDED	OVER REAR	10000	20
11	MAIN BOOM	100% EXTENDED	OVER REAR	8750	21
12	MAIN BOOM	100% EXTENDED	OVER REAR	7500	22
13	MAIN BOOM	100% EXTENDED	OVER REAR	6250	23
14	MAIN BOOM	100% EXTENDED	OVER REAR	5000	24
15	MAIN BOOM	100% EXTENDED	OVER REAR	3750	25
16	MAIN BOOM	100% EXTENDED	OVER REAR	2500	26
17	MAIN BOOM	100% EXTENDED	OVER REAR	1250	27
18	MAIN BOOM	100% EXTENDED	OVER REAR	0	28
19	MAIN BOOM	68% EXTENDED	FULL 360°	10000	29
20	MAIN BOOM	68% EXTENDED	FULL 360°	8750	30
21	MAIN BOOM	68% EXTENDED	FULL 360°	7500	31
22	MAIN BOOM	68% EXTENDED	FULL 360°	6250	32
23	MAIN BOOM	68% EXTENDED	FULL 360°	5000	33
24	MAIN BOOM	68% EXTENDED	FULL 360°	3750	34
25	MAIN BOOM	68% EXTENDED	FULL 360°	2500	35
26	MAIN BOOM	68% EXTENDED	FULL 360°	1250	36
27	MAIN BOOM	68% EXTENDED	FULL 360°	0	37
28	MAIN BOOM	68% EXTENDED	OVER REAR	10000	38
29	MAIN BOOM	68% EXTENDED	OVER REAR	8750	39
30	MAIN BOOM	68% EXTENDED	OVER REAR	7500	40
31	MAIN BOOM	68% EXTENDED	OVER REAR	6250	41
32	MAIN BOOM	68% EXTENDED	OVER REAR	5000	42
33	MAIN BOOM	68% EXTENDED	OVER REAR	3750	43
34	MAIN BOOM	68% EXTENDED	OVER REAR	2500	44
35	MAIN BOOM	68% EXTENDED	OVER REAR	1250	45
36	MAIN BOOM	68% EXTENDED	OVER REAR	0	46
37	MAIN BOOM	50% EXTENDED	FULL 360°	10000	47
38	MAIN BOOM	50% EXTENDED	FULL 360°	8750	48
39	MAIN BOOM	50% EXTENDED	FULL 360°	7500	49
40	MAIN BOOM	50% EXTENDED	FULL 360°	6250	50
41	MAIN BOOM	50% EXTENDED	FULL 360°	5000	51
42	MAIN BOOM	50% EXTENDED	FULL 360°	3750	52
43	MAIN BOOM	50% EXTENDED	FULL 360°	2500	53
44	MAIN BOOM	50% EXTENDED	FULL 360°	1250	54

CODE	CRANE CONFIGURATION	OUTRIGGER CONFIGURATION	AREA OF OPERATION	CWT (LBS)	PAGE
45	MAIN BOOM	50% EXTENDED	FULL 360°	0	55
46	MAIN BOOM	50% EXTENDED	OVER REAR	10000	56
47	MAIN BOOM	50% EXTENDED	OVER REAR	8750	57
48	MAIN BOOM	50% EXTENDED	OVER REAR	7500	58
49	MAIN BOOM	50% EXTENDED	OVER REAR	6250	59
50	MAIN BOOM	50% EXTENDED	OVER REAR	5000	60
51	MAIN BOOM	50% EXTENDED	OVER REAR	3750	61
52	MAIN BOOM	50% EXTENDED	OVER REAR	2500	62
53	MAIN BOOM	50% EXTENDED	OVER REAR	1250	63
54	MAIN BOOM	50% EXTENDED	OVER REAR	0	64
55	MAIN BOOM	RETRACTED	FULL 360°	10000	65
56	MAIN BOOM	RETRACTED	FULL 360°	8750	66
57	MAIN BOOM	RETRACTED	FULL 360°	7500	67
58	MAIN BOOM	RETRACTED	FULL 360°	6250	68
59	MAIN BOOM	RETRACTED	FULL 360°	5000	69
60	MAIN BOOM	RETRACTED	FULL 360°	3750	70
61	MAIN BOOM	RETRACTED	FULL 360°	2500	71
62	MAIN BOOM	RETRACTED	FULL 360°	1250	72
63	MAIN BOOM	RETRACTED	FULL 360°	0	73
64	RETRACTED JIB 0° OFFSET	100% EXTENDED	FULL 360°	10000	74
65	RETRACTED JIB 0° OFFSET	100% EXTENDED	FULL 360°	8750	75
66	RETRACTED JIB 0° OFFSET	100% EXTENDED	FULL 360°	7500	76
67	RETRACTED JIB 0° OFFSET	100% EXTENDED	FULL 360°	6250	77
68	RETRACTED JIB 0° OFFSET	100% EXTENDED	FULL 360°	5000	78
69	RETRACTED JIB 0° OFFSET	100% EXTENDED	FULL 360°	3750	79
70	RETRACTED JIB 0° OFFSET	100% EXTENDED	FULL 360°	2500	80
71	RETRACTED JIB 0° OFFSET	100% EXTENDED	FULL 360°	1250	81
72	RETRACTED JIB 0° OFFSET	100% EXTENDED	FULL 360°	0	82
73	RETRACTED JIB 15° OFFSET	100% EXTENDED	FULL 360°	10000	74
74	RETRACTED JIB 15° OFFSET	100% EXTENDED	FULL 360°	8750	75
75	RETRACTED JIB 15° OFFSET	100% EXTENDED	FULL 360°	7500	76
76	RETRACTED JIB 15° OFFSET	100% EXTENDED	FULL 360°	6250	77
77	RETRACTED JIB 15° OFFSET	100% EXTENDED	FULL 360°	5000	78
78	RETRACTED JIB 15° OFFSET	100% EXTENDED	FULL 360°	3750	79
79	RETRACTED JIB 15° OFFSET	100% EXTENDED	FULL 360°	2500	80
80	RETRACTED JIB 15° OFFSET	100% EXTENDED	FULL 360°	1250	81
81	RETRACTED JIB 15° OFFSET	100% EXTENDED	FULL 360°	0	82
82	RETRACTED JIB 30° OFFSET	100% EXTENDED	FULL 360°	10000	74
83	RETRACTED JIB 30° OFFSET	100% EXTENDED	FULL 360°	8750	75
84	RETRACTED JIB 30° OFFSET	100% EXTENDED	FULL 360°	7500	76
85	RETRACTED JIB 30° OFFSET	100% EXTENDED	FULL 360°	6250	77
86	RETRACTED JIB 30° OFFSET	100% EXTENDED	FULL 360°	5000	78
87	RETRACTED JIB 30° OFFSET	100% EXTENDED	FULL 360°	3750	79
88	RETRACTED JIB 30° OFFSET	100% EXTENDED	FULL 360°	2500	80
89	RETRACTED JIB 30° OFFSET	100% EXTENDED	FULL 360°	1250	81
90	RETRACTED JIB 30° OFFSET	100% EXTENDED	FULL 360°	0	82

CODE	CRANE CONFIGURATION	OUTRIGGER CONFIGURATION	AREA OF OPERATION	CWT (LBS)	PAGE
91	RETRACTED JIB 0° OFFSET	100% EXTENDED	OVER REAR	10000	74
92	RETRACTED JIB 0° OFFSET	100% EXTENDED	OVER REAR	8750	75
93	RETRACTED JIB 0° OFFSET	100% EXTENDED	OVER REAR	7500	76
94	RETRACTED JIB 0° OFFSET	100% EXTENDED	OVER REAR	6250	77
95	RETRACTED JIB 0° OFFSET	100% EXTENDED	OVER REAR	5000	78
96	RETRACTED JIB 0° OFFSET	100% EXTENDED	OVER REAR	3750	79
97	RETRACTED JIB 0° OFFSET	100% EXTENDED	OVER REAR	2500	80
98	RETRACTED JIB 0° OFFSET	100% EXTENDED	OVER REAR	1250	81
99	RETRACTED JIB 0° OFFSET	100% EXTENDED	OVER REAR	0	82
100	RETRACTED JIB 15° OFFSET	100% EXTENDED	OVER REAR	10000	74
101	RETRACTED JIB 15° OFFSET	100% EXTENDED	OVER REAR	8750	75
102	RETRACTED JIB 15° OFFSET	100% EXTENDED	OVER REAR	7500	76
103	RETRACTED JIB 15° OFFSET	100% EXTENDED	OVER REAR	6250	77
104	RETRACTED JIB 15° OFFSET	100% EXTENDED	OVER REAR	5000	78
105	RETRACTED JIB 15° OFFSET	100% EXTENDED	OVER REAR	3750	79
106	RETRACTED JIB 15° OFFSET	100% EXTENDED	OVER REAR	2500	80
107	RETRACTED JIB 15° OFFSET	100% EXTENDED	OVER REAR	1250	81
108	RETRACTED JIB 15° OFFSET	100% EXTENDED	OVER REAR	0	82
109	RETRACTED JIB 30° OFFSET	100% EXTENDED	OVER REAR	10000	74
110	RETRACTED JIB 30° OFFSET	100% EXTENDED	OVER REAR	8750	75
111	RETRACTED JIB 30° OFFSET	100% EXTENDED	OVER REAR	7500	76
112	RETRACTED JIB 30° OFFSET	100% EXTENDED	OVER REAR	6250	77
113	RETRACTED JIB 30° OFFSET	100% EXTENDED	OVER REAR	5000	78
114	RETRACTED JIB 30° OFFSET	100% EXTENDED	OVER REAR	3750	79
115	RETRACTED JIB 30° OFFSET	100% EXTENDED	OVER REAR	2500	80
116	RETRACTED JIB 30° OFFSET	100% EXTENDED	OVER REAR	1250	81
117	RETRACTED JIB 30° OFFSET	100% EXTENDED	OVER REAR	0	82
118	EXTENDED JIB 0° OFFSET	100% EXTENDED	FULL 360°	10000	83
119	EXTENDED JIB 0° OFFSET	100% EXTENDED	FULL 360°	8750	84
120	EXTENDED JIB 0° OFFSET	100% EXTENDED	FULL 360°	7500	85
121	EXTENDED JIB 0° OFFSET	100% EXTENDED	FULL 360°	6250	86
122	EXTENDED JIB 0° OFFSET	100% EXTENDED	FULL 360°	5000	87
123	EXTENDED JIB 0° OFFSET	100% EXTENDED	FULL 360°	3750	88
124	EXTENDED JIB 0° OFFSET	100% EXTENDED	FULL 360°	2500	89
125	EXTENDED JIB 0° OFFSET	100% EXTENDED	FULL 360°	1250	90
126	EXTENDED JIB 0° OFFSET	100% EXTENDED	FULL 360°	0	91
127	EXTENDED JIB 15° OFFSET	100% EXTENDED	FULL 360°	10000	83
128	EXTENDED JIB 15° OFFSET	100% EXTENDED	FULL 360°	8750	84
129	EXTENDED JIB 15° OFFSET	100% EXTENDED	FULL 360°	7500	85
130	EXTENDED JIB 15° OFFSET	100% EXTENDED	FULL 360°	6250	86
131	EXTENDED JIB 15° OFFSET	100% EXTENDED	FULL 360°	5000	87
132	EXTENDED JIB 15° OFFSET	100% EXTENDED	FULL 360°	3750	88
133	EXTENDED JIB 15° OFFSET	100% EXTENDED	FULL 360°	2500	89
134	EXTENDED JIB 15° OFFSET	100% EXTENDED	FULL 360°	1250	90
135	EXTENDED JIB 15° OFFSET	100% EXTENDED	FULL 360°	0	91
136	EXTENDED JIB 30° OFFSET	100% EXTENDED	FULL 360°	10000	83

CODE	CRANE CONFIGURATION	OUTRIGGER CONFIGURATION	AREA OF OPERATION	CWT (LBS)	PAGE
137	EXTENDED JIB 30° OFFSET	100% EXTENDED	FULL 360°	8750	84
138	EXTENDED JIB 30° OFFSET	100% EXTENDED	FULL 360°	7500	85
139	EXTENDED JIB 30° OFFSET	100% EXTENDED	FULL 360°	6250	86
140	EXTENDED JIB 30° OFFSET	100% EXTENDED	FULL 360°	5000	87
141	EXTENDED JIB 30° OFFSET	100% EXTENDED	FULL 360°	3750	88
142	EXTENDED JIB 30° OFFSET	100% EXTENDED	FULL 360°	2500	89
143	EXTENDED JIB 30° OFFSET	100% EXTENDED	FULL 360°	1250	90
144	EXTENDED JIB 30° OFFSET	100% EXTENDED	FULL 360°	0	91
145	EXTENDED JIB 0° OFFSET	100% EXTENDED	OVER REAR	10000	83
146	EXTENDED JIB 0° OFFSET	100% EXTENDED	OVER REAR	8750	84
147	EXTENDED JIB 0° OFFSET	100% EXTENDED	OVER REAR	7500	85
148	EXTENDED JIB 0° OFFSET	100% EXTENDED	OVER REAR	6250	86
149	EXTENDED JIB 0° OFFSET	100% EXTENDED	OVER REAR	5000	87
150	EXTENDED JIB 0° OFFSET	100% EXTENDED	OVER REAR	3750	88
151	EXTENDED JIB 0° OFFSET	100% EXTENDED	OVER REAR	2500	89
152	EXTENDED JIB 0° OFFSET	100% EXTENDED	OVER REAR	1250	90
153	EXTENDED JIB 0° OFFSET	100% EXTENDED	OVER REAR	0	91
154	EXTENDED JIB 15° OFFSET	100% EXTENDED	OVER REAR	10000	83
155	EXTENDED JIB 15° OFFSET	100% EXTENDED	OVER REAR	8750	84
156	EXTENDED JIB 15° OFFSET	100% EXTENDED	OVER REAR	7500	85
157	EXTENDED JIB 15° OFFSET	100% EXTENDED	OVER REAR	6250	86
158	EXTENDED JIB 15° OFFSET	100% EXTENDED	OVER REAR	5000	87
159	EXTENDED JIB 15° OFFSET	100% EXTENDED	OVER REAR	3750	88
160	EXTENDED JIB 15° OFFSET	100% EXTENDED	OVER REAR	2500	89
161	EXTENDED JIB 15° OFFSET	100% EXTENDED	OVER REAR	1250	90
162	EXTENDED JIB 15° OFFSET	100% EXTENDED	OVER REAR	0	91
163	EXTENDED JIB 30° OFFSET	100% EXTENDED	OVER REAR	10000	83
164	EXTENDED JIB 30° OFFSET	100% EXTENDED	OVER REAR	8750	84
165	EXTENDED JIB 30° OFFSET	100% EXTENDED	OVER REAR	7500	85
166	EXTENDED JIB 30° OFFSET	100% EXTENDED	OVER REAR	6250	86
167	EXTENDED JIB 30° OFFSET	100% EXTENDED	OVER REAR	5000	87
168	EXTENDED JIB 30° OFFSET	100% EXTENDED	OVER REAR	3750	88
169	EXTENDED JIB 30° OFFSET	100% EXTENDED	OVER REAR	2500	89
170	EXTENDED JIB 30° OFFSET	100% EXTENDED	OVER REAR	1250	90
171	EXTENDED JIB 30° OFFSET	100% EXTENDED	OVER REAR	0	91
172	FIXED JIB 0° OFFSET	100% EXTENDED	FULL 360°	10000	92
173	FIXED JIB 0° OFFSET	100% EXTENDED	FULL 360°	8750	93
174	FIXED JIB 0° OFFSET	100% EXTENDED	FULL 360°	7500	94
175	FIXED JIB 0° OFFSET	100% EXTENDED	FULL 360°	6250	95
176	FIXED JIB 0° OFFSET	100% EXTENDED	FULL 360°	5000	96
177	FIXED JIB 0° OFFSET	100% EXTENDED	FULL 360°	3750	97
178	FIXED JIB 0° OFFSET	100% EXTENDED	FULL 360°	2500	98
179	FIXED JIB 0° OFFSET	100% EXTENDED	FULL 360°	1250	99
180	FIXED JIB 0° OFFSET	100% EXTENDED	FULL 360°	0	100
181	FIXED JIB 15° OFFSET	100% EXTENDED	FULL 360°	10000	92
182	FIXED JIB 15° OFFSET	100% EXTENDED	FULL 360°	8750	93

CODE	CRANE CONFIGURATION	OUTRIGGER CONFIGURATION	AREA OF OPERATION	CWT (LBS)	PAGE
183	FIXED JIB 15° OFFSET	100% EXTENDED	FULL 360°	7500	94
184	FIXED JIB 15° OFFSET	100% EXTENDED	FULL 360°	6250	95
185	FIXED JIB 15° OFFSET	100% EXTENDED	FULL 360°	5000	96
186	FIXED JIB 15° OFFSET	100% EXTENDED	FULL 360°	3750	97
187	FIXED JIB 15° OFFSET	100% EXTENDED	FULL 360°	2500	98
188	FIXED JIB 15° OFFSET	100% EXTENDED	FULL 360°	1250	99
189	FIXED JIB 15° OFFSET	100% EXTENDED	FULL 360°	0	100
190	FIXED JIB 30° OFFSET	100% EXTENDED	FULL 360°	10000	92
191	FIXED JIB 30° OFFSET	100% EXTENDED	FULL 360°	8750	93
192	FIXED JIB 30° OFFSET	100% EXTENDED	FULL 360°	7500	94
193	FIXED JIB 30° OFFSET	100% EXTENDED	FULL 360°	6250	95
194	FIXED JIB 30° OFFSET	100% EXTENDED	FULL 360°	5000	96
195	FIXED JIB 30° OFFSET	100% EXTENDED	FULL 360°	3750	97
196	FIXED JIB 30° OFFSET	100% EXTENDED	FULL 360°	2500	98
197	FIXED JIB 30° OFFSET	100% EXTENDED	FULL 360°	1250	99
198	FIXED JIB 30° OFFSET	100% EXTENDED	FULL 360°	0	100
199	FIXED JIB 0° OFFSET	100% EXTENDED	OVER REAR	10000	92
200	FIXED JIB 0° OFFSET	100% EXTENDED	OVER REAR	8750	93
201	FIXED JIB 0° OFFSET	100% EXTENDED	OVER REAR	7500	94
202	FIXED JIB 0° OFFSET	100% EXTENDED	OVER REAR	6250	95
203	FIXED JIB 0° OFFSET	100% EXTENDED	OVER REAR	5000	96
204	FIXED JIB 0° OFFSET	100% EXTENDED	OVER REAR	3750	97
205	FIXED JIB 0° OFFSET	100% EXTENDED	OVER REAR	2500	98
206	FIXED JIB 0° OFFSET	100% EXTENDED	OVER REAR	1250	99
207	FIXED JIB 0° OFFSET	100% EXTENDED	OVER REAR	0	100
208	FIXED JIB 15° OFFSET	100% EXTENDED	OVER REAR	10000	92
209	FIXED JIB 15° OFFSET	100% EXTENDED	OVER REAR	8750	93
210	FIXED JIB 15° OFFSET	100% EXTENDED	OVER REAR	7500	94
211	FIXED JIB 15° OFFSET	100% EXTENDED	OVER REAR	6250	95
212	FIXED JIB 15° OFFSET	100% EXTENDED	OVER REAR	5000	96
213	FIXED JIB 15° OFFSET	100% EXTENDED	OVER REAR	3750	97
214	FIXED JIB 15° OFFSET	100% EXTENDED	OVER REAR	2500	98
215	FIXED JIB 15° OFFSET	100% EXTENDED	OVER REAR	1250	99
216	FIXED JIB 15° OFFSET	100% EXTENDED	OVER REAR	0	100
217	FIXED JIB 30° OFFSET	100% EXTENDED	OVER REAR	10000	92
218	FIXED JIB 30° OFFSET	100% EXTENDED	OVER REAR	8750	93
219	FIXED JIB 30° OFFSET	100% EXTENDED	OVER REAR	7500	94
220	FIXED JIB 30° OFFSET	100% EXTENDED	OVER REAR	6250	95
221	FIXED JIB 30° OFFSET	100% EXTENDED	OVER REAR	5000	96
222	FIXED JIB 30° OFFSET	100% EXTENDED	OVER REAR	3750	97
223	FIXED JIB 30° OFFSET	100% EXTENDED	OVER REAR	2500	98
224	FIXED JIB 30° OFFSET	100% EXTENDED	OVER REAR	1250	99
225	FIXED JIB 30° OFFSET	100% EXTENDED	OVER REAR	0	100

WARNING







1. THE OPERATOR MUST READ AND UNDERSTAND THE OWNER'S MANUAL BEFORE OPERATING THIS CRANE.
2. POSITIONING OR OPERATION OF CRANE BEYOND AREAS SHOWN ON THIS CHART IS NOT INTENDED OR APPROVED EXCEPT WHERE SPECIFIED IN OWNER'S MANUAL. SHADED LOADS ARE STABILITY LIMITED.
3. LOADED BOOM ANGLES AT SPECIFIED BOOM LENGTHS GIVE ONLY AN APPROXIMATION OF THE OPERATING RADIUS. THE BOOM ANGLE BEFORE LOADING SHOULD BE GREATER TO ACCOUNT FOR DEFLECTIONS. DO NOT EXCEED THE OPERATING RADIUS FOR RATED LOADS.
4. THE OPERATING RADIUS SHOWN IN THE JIB RATING CHART IS FOR 100% EXTENDED BOOM ONLY. WHEN BOOM IS NOT 100% EXTENDED, USE ONLY LOADED BOOM ANGLE TO DETERMINE LOAD RATING OF JIB.
5. FOR BOOM ANGLES NOT SHOWN ON JIB LOAD CHART, USE RATING OF NEXT LOWER BOOM ANGLE.
6. FOR BOOM LENGTHS NOT SHOWN, USE RATING OF NEXT SHORTER OR LONGER BOOM LENGTH, WHICHEVER IS LESS. FOR RADII NOT SHOWN, USE RATING OF NEXT LONGER RADIUS.
7. CRANE LOAD RATINGS ON OUTRIGGERS ARE BASED ON FREELY SUSPENDED LOADS WITH THE MACHINE LEVELED AND STANDING ON A FIRM UNIFORM SUPPORTING SURFACE. NO ATTEMPT SHALL BE MADE TO MOVE A LOAD HORIZONTALLY ON THE GROUND IN ANY DIRECTION.
8. PRACTICAL WORKING LOADS DEPEND ON SUPPORTING SURFACE, WIND AND OTHER FACTORS AFFECTING STABILITY SUCH AS HAZARDOUS SURROUNDINGS, EXPERIENCE OF PERSONNEL AND PROPER HANDLING, ALL OF WHICH MUST BE TAKEN INTO ACCOUNT BY THE OPERATOR.
9. THE MAXIMUM LOAD WHICH MAY BE TELESCOPED IS LIMITED BY HYDRAULIC PRESSURE, BOOM ANGLE AND BOOM LUBRICATION. IT IS SAFE TO ATTEMPT TO TELESCOPE ANY LOAD WITHIN THE LIMITS OF THE LOAD RATING CHART.

INFORMATION

1. DEDUCTIONS MUST BE MADE FROM RATED LOADS FOR JIB, OPTIONAL ATTACHMENTS, HOOKS AND LOADBLOCKS (SEE DEDUCTION CHART). WEIGHTS OF SLINGS AND ALL OTHER LOAD HANDLING DEVICES SHALL BE CONSIDERED AS PART OF THE LOAD.
2. LOAD RATINGS ABOVE THE HEAVY LINE ARE STRUCTURALLY LIMITED CAPACITIES. LOAD RATINGS BELOW THE HEAVY LINE ARE STABILITY LIMITED CAPACITIES AND DO NOT EXCEED 85% OF TIPPING.

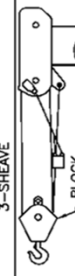
DEFINITIONS

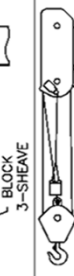
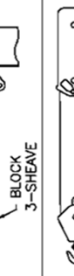
1. OPERATING RADIUS IS THE HORIZONTAL DISTANCE FROM THE AXIS OF ROTATION TO THE CENTER OF THE VERTICAL HOIST LINE OR TACKLE WITH LOAD APPLIED.
2. LOADED BOOM ANGLE IS THE INCLUDED ANGLE BETWEEN THE HORIZONTAL AND LONGITUDINAL AXES OF THE BOOM BASE AFTER LIFTING RATED LOAD AT THE RATED RADIUS.

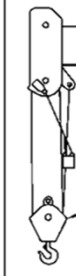
ALLOWABLE LINE PULL											WARNING
1 PART LINE	2 PART LINE	3 PART LINE	4 PART LINE	5 PART LINE	6 PART LINE	7 PART LINE	8 PART LINE	9 PART LINE	10 PART LINE	11 PART LINE	
											
12000 LBS	24000 LBS	36000 LBS	48000 LBS	60000 LBS	72000 LBS	84000 LBS	96000 LBS	108000 LBS	120000 LBS	132000 LBS	5/8" ROT RESISTANT (5:1 SF) 61,200 LBS MIN BREAKING STRENGTH

AREA OF OPERATIONS

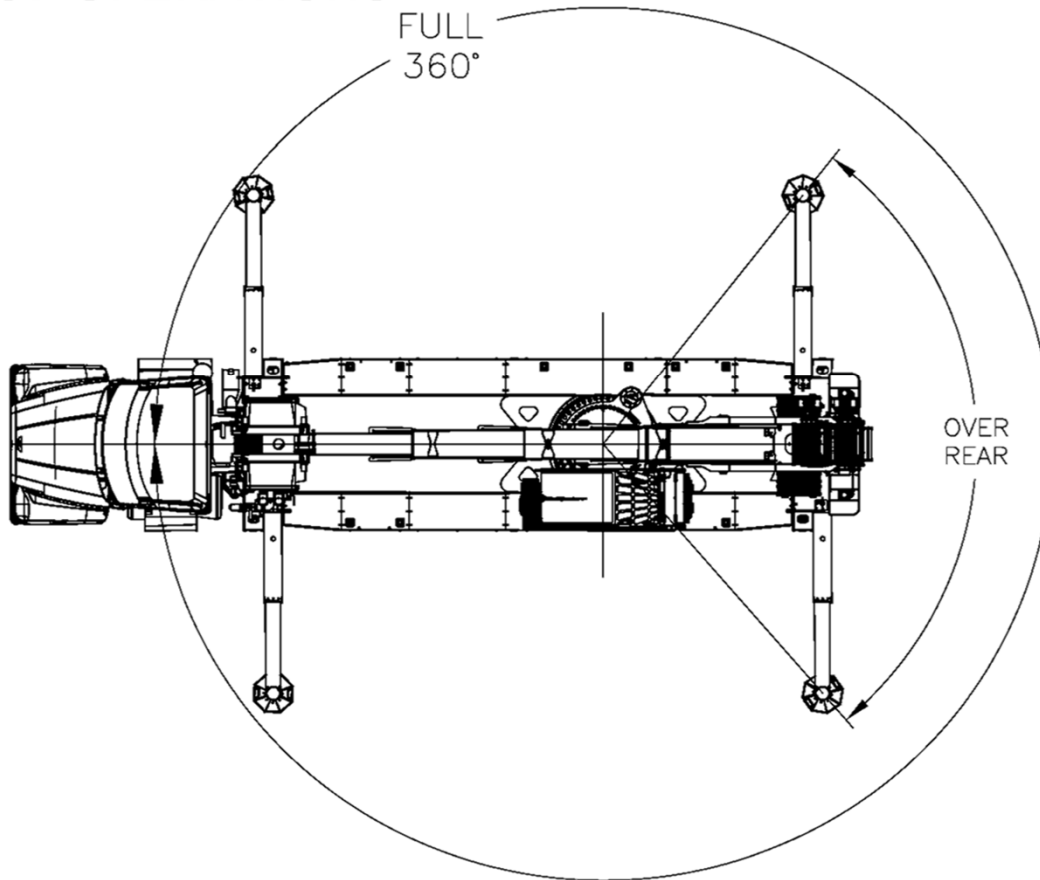

DEDUCTIONS FROM RATED LOADS FOR LOAD HANDLING DEVICES SUPPLIED BY MANITEX

AUXILIARY BLOCK-----	50 LBS
AUXILIARY (ROOSTER) SHEAVE-----	70 LBS
LIFTING FROM MAIN BOOM WITH JIB STOWED OR ERECTED-----	SEE LOAD CHART
OVERHAUL BALL-----	SEE MANUFACTURER NAMEPLATE
LOAD BLOCK-----	SEE MANUFACTURER NAMEPLATE

- RANGE DIAGRAM -

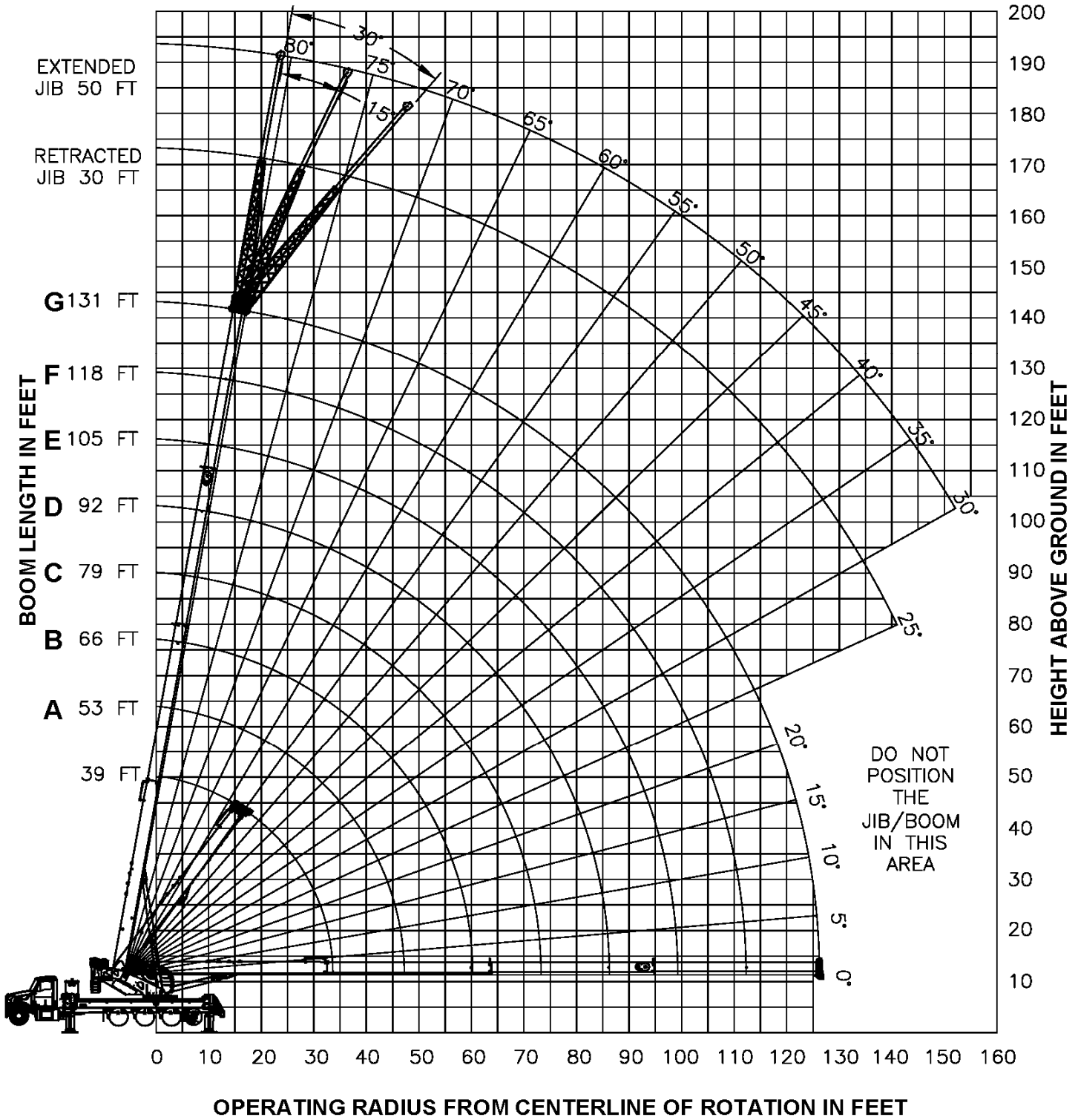

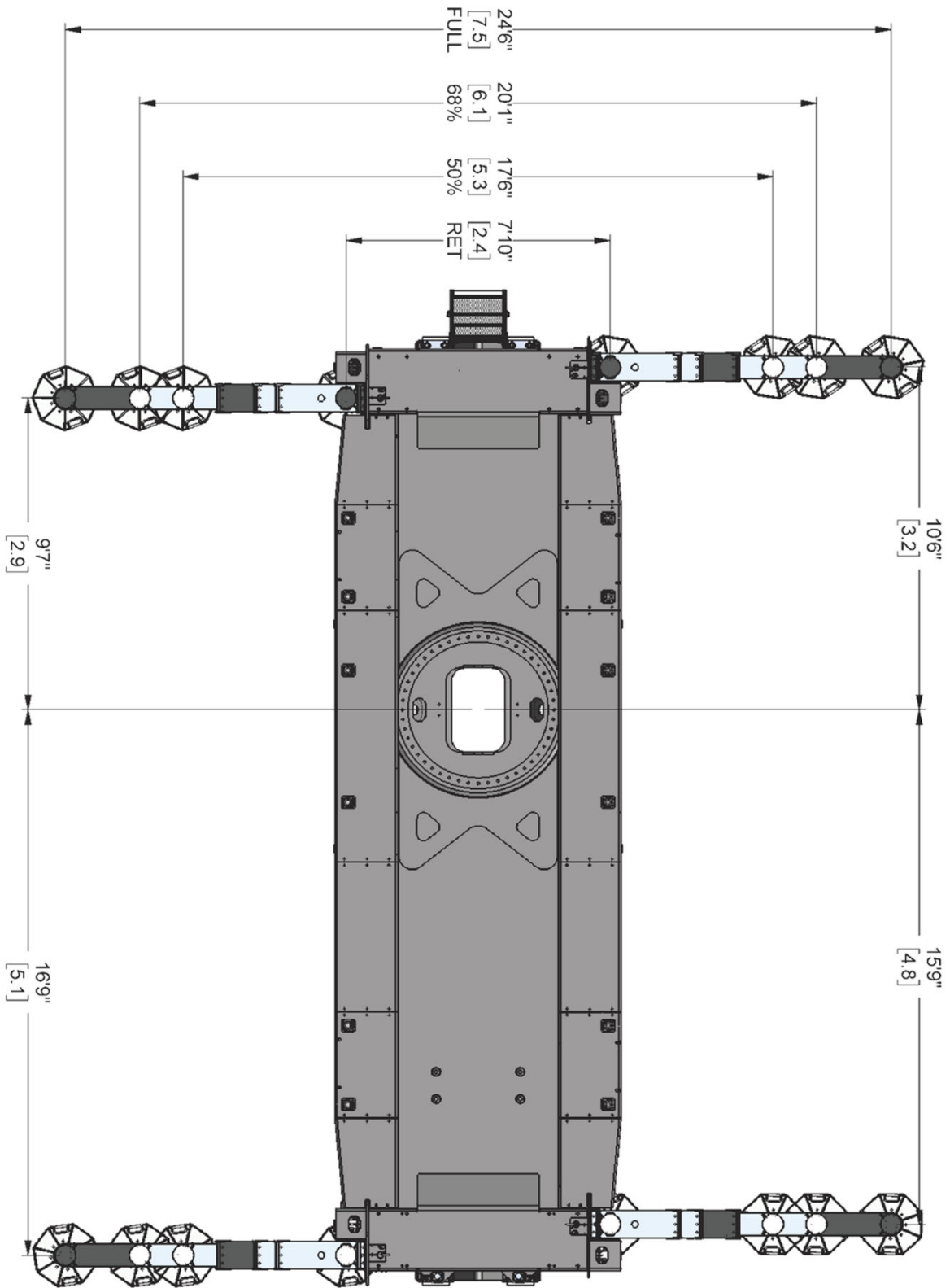

Dimensions are in feet [meters] unless otherwise specified

CODE 1

MAIN BOOM

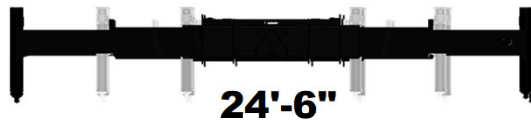

LOAD RADIUS (FT)	ANGLE	LIFTING CAP. (LBS)	ANGLE	LIFTING CAP. (LBS)	ANGLE	LIFTING CAP. (LBS)	ANGLE	LIFTING CAP. (LBS)	ANGLE	LIFTING CAP. (LBS)	ANGLE	LIFTING CAP. (LBS)	ANGLE	LIFTING CAP. (LBS)	ANGLE	LIFTING CAP. (LBS)	LOAD RADIUS (FT)
LENGTH	39.3 FT		53 FT		66 FT		79 FT		92 FT		105 FT		118 FT		131 FT		
6	74°	130000															6
8	70°	120000															8
10	67°	104870	74°	80000	77°	73200											10
12	64°	95630	71°	80000	76°	68990	78°	54510									12
15	59°	84050	68°	74250	73°	62490	76°	49640	79°	38040							15
20	50°	65540	62°	62410	68°	53070	72°	43090	75°	33510	78°	28990					20
25	40°	50810	55°	51800	63°	46050	69°	37560	72°	29440	75°	25810	77°	22810			25
30	26°	40810	49°	41860	58°	40230	65°	33320	69°	26050	72°	23390	75°	20770	77°	18180	30
35			41°	34350	53°	35090	61°	29630	66°	23500	69°	21000	73°	18830	75°	16770	35
40			31°	26710	47°	27420	56°	26450	62°	21000	66°	18910	70°	17110	73°	15360	40
45			18°	21340	41°	22090	52°	22510	58°	18920	63°	17130	67°	15520	70°	14070	45
50					35°	18150	47°	18570	55°	17110	60°	15540	65°	14150	68°	12900	50
55					28°	15110	41°	15550	51°	15570	57°	14150	62°	12930	66°	12100	55
60					18°	12630	35°	13150	46°	13430	54°	12920	59°	12100	63°	11110	60
65							28°	11200	42°	11490	50°	11680	56°	11100	61°	10190	65
70							18°	9560	36°	9870	46°	10070	53°	10190	58°	9370	70
75									30°	8510	42°	8710	50°	8850	55°	8620	75
80									23°	7340	38°	7550	46°	7690	52°	7800	80
85									11°	6300	33°	6550	43°	6690	49°	6800	85
90											27°	5670	39°	5820	46°	5930	90
95											19°	4850	34°	5030	43°	5150	95
100													29°	4310	39°	4440	100
105													23°	3670	36°	3800	105
110													14°	3080	31°	3230	110
115															26°	2710	115
120															19°	2240	120
125															6°	1790	125
130																	130
DEDUCTIONS FOR MAIN BOOM CAPACITIES	0°	30700	0°	18200	0°	12450	0°	8350	0°	6050	0°	4250	0°	2900	0°	600	
		1570		1140		920		770		660		580		520		460	STOWED
		3510		3240		3100		3010		2940		2890		2850		2820	RET
		3910		3530		3340		3200		3110		3040		2980		2940	EXT
	2620		2420		2320		2250		2200		2170		2140		2120	FIXED	

CODE 2

MAIN BOOM

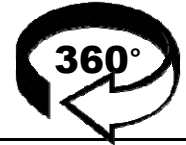
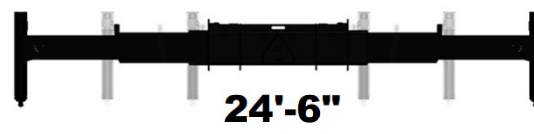
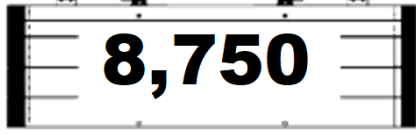

LOAD RADIUS (FT)	ANGLE	LIFTING CAP. (LBS)	ANGLE	LIFTING CAP. (LBS)	ANGLE	LIFTING CAP. (LBS)	ANGLE	LIFTING CAP. (LBS)	ANGLE	LIFTING CAP. (LBS)	ANGLE	LIFTING CAP. (LBS)	ANGLE	LIFTING CAP. (LBS)	ANGLE	LIFTING CAP. (LBS)	LOAD RADIUS (FT)
LENGTH	39.3 FT		53 FT		66 FT		79 FT		92 FT		105 FT		118 FT		131 FT		
6	74°	130000															6
8	70°	120000															8
10	67°	104870	74°	80000	77°	73200											10
12	64°	95630	71°	80000	76°	68990	78°	54510									12
15	59°	84050	68°	74250	73°	62490	76°	49640	79°	38040							15
20	50°	64890	62°	62410	68°	53070	72°	43090	75°	33510	78°	28990					20
25	40°	50280	55°	51280	63°	46050	69°	37560	72°	29440	75°	25810	77°	22810			25
30	26°	40370	49°	41420	58°	40230	65°	33320	69°	26050	72°	23390	75°	20770	77°	18180	30
35			41°	33260	53°	33990	61°	29630	66°	23500	69°	21000	73°	18830	75°	16770	35
40			31°	25810	47°	26520	56°	26450	62°	21000	66°	18910	70°	17110	73°	15360	40
45			18°	20580	41°	21330	52°	21750	58°	18920	63°	17130	67°	15520	70°	14070	45
50					35°	17490	47°	17910	55°	17110	60°	15540	65°	14150	68°	12900	50
55					28°	14530	41°	14970	51°	15240	57°	14150	62°	12930	66°	12100	55
60					18°	12110	35°	12630	46°	12910	54°	12920	59°	12100	63°	11110	60
65							28°	10730	42°	11010	50°	11210	56°	11100	61°	10190	65
70							18°	9130	36°	9440	46°	9640	53°	9780	58°	9370	70
75									30°	8110	42°	8310	50°	8460	55°	8560	75
80									23°	6970	38°	7180	46°	7330	52°	7430	80
85									11°	5930	33°	6190	43°	6350	49°	6460	85
90											27°	5280	39°	5450	46°	5570	90
95											19°	4480	34°	4660	43°	4780	95
100													29°	3970	39°	4090	100
105													23°	3340	36°	3470	105
110													14°	2770	31°	2920	110
115															26°	2420	115
120															19°	1960	120
125															6°	1520	125
130																	130
DEDUCTIONS FOR MAIN BOOM CAPACITIES	0°	30500	0°	17800	0°	11950	0°	8200	0°	5700	0°	3950	0°	2600	0°	600	
		1570		1140		920		770		660		580		520		460	STOWED
		3510		3240		3100		3010		2940		2890		2850		2820	RET
		3910		3530		3340		3200		3110		3040		2980		2940	EXT
	2620		2420		2320		2250		2200		2170		2140		2120	FIXED	

CODE 3

MAIN BOOM

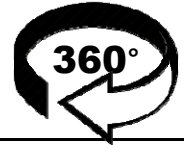
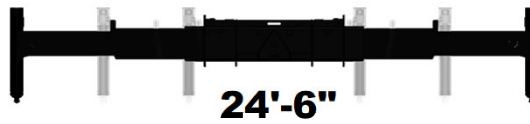
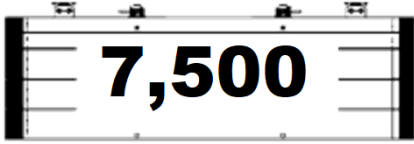

LOAD RADIUS (FT)	ANGLE	LIFTING CAP. (LBS)	ANGLE	LIFTING CAP. (LBS)	ANGLE	LIFTING CAP. (LBS)	ANGLE	LIFTING CAP. (LBS)	ANGLE	LIFTING CAP. (LBS)	ANGLE	LIFTING CAP. (LBS)	ANGLE	LIFTING CAP. (LBS)	ANGLE	LIFTING CAP. (LBS)	LOAD RADIUS (FT)
LENGTH	39.3 FT		53 FT		66 FT		79 FT		92 FT		105 FT		118 FT		131 FT		
6	74°	130000															6
8	70°	120000															8
10	67°	104870	74°	80000	77°	73200											10
12	64°	95630	71°	80000	76°	68990	78°	54510									12
15	59°	84050	68°	74250	73°	62490	76°	49640	79°	38040							15
20	50°	64240	62°	62410	68°	53070	72°	43090	75°	33510	78°	28990					20
25	40°	49760	55°	50750	63°	46050	69°	37560	72°	29440	75°	25810	77°	22810			25
30	26°	39930	49°	40980	58°	40230	65°	33320	69°	26050	72°	23390	75°	20770	77°	18180	30
35			41°	32160	53°	32890	61°	29630	66°	23500	69°	21000	73°	18830	75°	16770	35
40			31°	24910	47°	25620	56°	26060	62°	21000	66°	18910	70°	17110	73°	15360	40
45			18°	19820	41°	20560	52°	20990	58°	18920	63°	17130	67°	15520	70°	14070	45
50					35°	16830	47°	17250	55°	17110	60°	15540	65°	14150	68°	12900	50
55					28°	13950	41°	14380	51°	14660	57°	14150	62°	12930	66°	12100	55
60					18°	11590	35°	12110	46°	12390	54°	12580	59°	12100	63°	11110	60
65							28°	10250	42°	10540	50°	10730	56°	10880	61°	10190	65
70							18°	8700	36°	9010	46°	9200	53°	9350	58°	9370	70
75									30°	7710	42°	7920	50°	8060	55°	8160	75
80									23°	6540	38°	6770	46°	6930	52°	7040	80
85									11°	5500	33°	5770	43°	5920	49°	6040	85
90											27°	4890	39°	5050	46°	5170	90
95											19°	4110	34°	4290	43°	4410	95
100													29°	3620	39°	3740	100
105													23°	3010	36°	3140	105
110													14°	2460	31°	2610	110
115															26°	2120	115
120															19°	1680	120
125															6°	1250	125
130																	130
DEDUCTIONS FOR MAIN BOOM CAPACITIES	0°	30300	0°	17350	0°	11500	0°	7800	0°	5300	0°	3650	0°	2300	0°	600	
		1570		1140		920		770		660		580		520		460	STOWED
		3510		3240		3100		3010		2940		2890		2850		2820	RET
		3910		3530		3340		3200		3110		3040		2980		2940	EXT
	2620		2420		2320		2250		2200		2170		2140		2120	FIXED	

CODE 4

MAIN BOOM

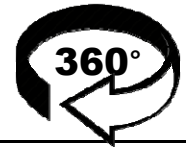
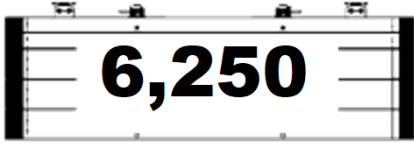

LOAD RADIUS (FT)	ANGLE	LIFTING CAP. (LBS)	ANGLE	LIFTING CAP. (LBS)	ANGLE	LIFTING CAP. (LBS)	ANGLE	LIFTING CAP. (LBS)	ANGLE	LIFTING CAP. (LBS)	ANGLE	LIFTING CAP. (LBS)	ANGLE	LIFTING CAP. (LBS)	ANGLE	LIFTING CAP. (LBS)	LOAD RADIUS (FT)
LENGTH	39.3 FT		53 FT		66 FT		79 FT		92 FT		105 FT		118 FT		131 FT		
6	74°	130000															6
8	70°	120000															8
10	67°	104870	74°	80000	77°	73200											10
12	64°	95630	71°	80000	76°	68990	78°	54510									12
15	59°	84050	68°	74250	73°	62490	76°	49640	79°	38040							15
20	50°	63580	62°	62410	68°	53070	72°	43090	75°	33510	78°	28990					20
25	40°	49240	55°	50230	63°	46050	69°	37560	72°	29440	75°	25810	77°	22810			25
30	26°	39490	49°	40540	58°	40230	65°	33320	69°	26050	72°	23390	75°	20770	77°	18180	30
35			41°	31060	53°	31800	61°	29630	66°	23500	69°	21000	73°	18830	75°	16770	35
40			31°	24010	47°	24720	56°	25160	62°	21000	66°	18910	70°	17110	73°	15360	40
45			18°	19050	41°	19800	52°	20230	58°	18920	63°	17130	67°	15520	70°	14070	45
50					35°	16170	47°	16590	55°	16870	60°	15540	65°	14150	68°	12900	50
55					28°	13360	41°	13800	51°	14080	57°	14150	62°	12930	66°	12100	55
60					18°	11070	35°	11590	46°	11860	54°	12060	59°	12100	63°	11110	60
65							28°	9780	42°	10070	50°	10260	56°	10400	61°	10190	65
70							18°	8240	36°	8570	46°	8770	53°	8910	58°	9020	70
75									30°	7230	42°	7450	50°	7600	55°	7720	75
80									23°	6090	38°	6310	46°	6470	52°	6590	80
85									11°	5080	33°	5340	43°	5500	49°	5620	85
90											27°	4490	39°	4660	46°	4780	90
95											19°	3740	34°	3920	43°	4040	95
100													29°	3270	39°	3390	100
105													23°	2690	36°	2820	105
110													14°	2150	31°	2300	110
115															26°	1830	115
120															19°	1400	120
125															6°	980	125
130																	130
DEDUCTIONS FOR MAIN BOOM CAPACITIES	0°	30100	0°	16950	0°	10950	0°	7400	0°	4900	0°	3350	0°	2050	0°	600	
		1570		1140		920		770		660		580		520		460	STOWED
		3510		3240		3100		3010		2940		2890		2850		2820	RET
		3910		3530		3340		3200		3110		3040		2980		2940	EXT
	2620		2420		2320		2250		2200		2170		2140		2120	FIXED	

CODE 5

MAIN BOOM

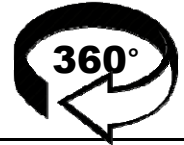

LOAD RADIUS (FT)	ANGLE	LIFTING CAP. (LBS)	ANGLE	LIFTING CAP. (LBS)	ANGLE	LIFTING CAP. (LBS)	ANGLE	LIFTING CAP. (LBS)	ANGLE	LIFTING CAP. (LBS)	ANGLE	LIFTING CAP. (LBS)	ANGLE	LIFTING CAP. (LBS)	ANGLE	LIFTING CAP. (LBS)	LOAD RADIUS (FT)
LENGTH	39.3 FT		53 FT		66 FT		79 FT		92 FT		105 FT		118 FT		131 FT		
6	74°	130000															6
8	70°	120000															8
10	67°	104870	74°	80000	77°	73200											10
12	64°	95630	71°	80000	76°	68990	78°	54510									12
15	59°	84050	68°	74250	73°	62490	76°	49640	79°	38040							15
20	50°	62930	62°	62410	68°	53070	72°	43090	75°	33510	78°	28990					20
25	40°	48710	55°	49700	63°	46050	69°	37560	72°	29440	75°	25810	77°	22810			25
30	26°	39050	49°	40100	58°	40230	65°	33320	69°	26050	72°	23390	75°	20770	77°	18180	30
35			41°	29960	53°	30700	61°	29630	66°	23500	69°	21000	73°	18830	75°	16770	35
40			31°	23110	47°	23830	56°	24260	62°	21000	66°	18910	70°	17110	73°	15360	40
45			18°	18290	41°	19040	52°	19460	58°	18920	63°	17130	67°	15520	70°	14070	45
50					35°	15510	47°	15930	55°	16210	60°	15540	65°	14150	68°	12900	50
55					28°	12780	41°	13220	51°	13490	57°	13690	62°	12930	66°	12100	55
60					18°	10540	35°	11060	46°	11340	54°	11540	59°	11680	63°	11110	60
65							28°	9270	42°	9590	50°	9790	56°	9930	61°	10040	65
70							18°	7700	36°	8030	46°	8250	53°	8400	58°	8520	70
75									30°	6730	42°	6950	50°	7110	55°	7220	75
80									23°	5630	38°	5860	46°	6010	52°	6130	80
85									11°	4660	33°	4920	43°	5080	49°	5190	85
90											27°	4100	39°	4260	46°	4380	90
95											19°	3370	34°	3550	43°	3670	95
100													29°	2920	39°	3050	100
105													23°	2360	36°	2490	105
110													14°	1840	31°	1990	110
115															26°	1530	115
120															19°	1120	120
125																	125
130																	130
DEDUCTIONS FOR MAIN BOOM CAPACITIES	0°	29900	0°	16500	0°	10450	0°	6950	0°	4500	0°	3050	0°	1750	0°	600	
		1570		1140		920		770		660		580		520		460	STOWED
		3510		3240		3100		3010		2940		2890		2850		2820	RET
		3910		3530		3340		3200		3110		3040		2980		2940	EXT
	2620		2420		2320		2250		2200		2170		2140		2120	FIXED	

CODE 6

MAIN BOOM

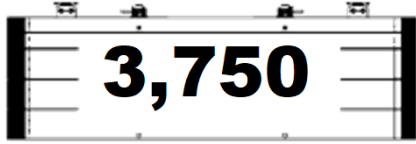

LOAD RADIUS (FT)	ANGLE	LIFTING CAP. (LBS)	ANGLE	LIFTING CAP. (LBS)	ANGLE	LIFTING CAP. (LBS)	ANGLE	LIFTING CAP. (LBS)	ANGLE	LIFTING CAP. (LBS)	ANGLE	LIFTING CAP. (LBS)	ANGLE	LIFTING CAP. (LBS)	ANGLE	LIFTING CAP. (LBS)	LOAD RADIUS (FT)
LENGTH	39.3 FT		53 FT		66 FT		79 FT		92 FT		105 FT		118 FT		131 FT		
6	74°	130000															6
8	70°	120000															8
10	67°	104870	74°	80000	77°	73200											10
12	64°	95630	71°	80000	76°	68990	78°	54510									12
15	59°	84050	68°	74250	73°	62490	76°	49640	79°	38040							15
20	50°	62280	62°	62410	68°	53070	72°	43090	75°	33510	78°	28990					20
25	40°	48190	55°	49180	63°	46050	69°	37560	72°	29440	75°	25810	77°	22810			25
30	26°	37660	49°	39230	58°	40020	65°	33320	69°	26050	72°	23390	75°	20770	77°	18180	30
35			41°	28870	53°	29600	61°	29630	66°	23500	69°	21000	73°	18830	75°	16770	35
40			31°	22210	47°	22930	56°	23360	62°	21000	66°	18910	70°	17110	73°	15360	40
45			18°	17530	41°	18280	52°	18700	58°	18920	63°	17130	67°	15520	70°	14070	45
50					35°	14840	47°	15270	55°	15550	60°	15540	65°	14150	68°	12900	50
55					28°	12190	41°	12630	51°	12910	57°	13110	62°	12930	66°	12100	55
60					18°	9950	35°	10520	46°	10820	54°	11010	59°	11160	63°	11110	60
65							28°	8680	42°	8990	50°	9200	56°	9360	61°	9490	65
70							18°	7150	36°	7490	46°	7700	53°	7860	58°	7980	70
75									30°	6240	42°	6460	50°	6610	55°	6730	75
80									23°	5170	38°	5400	46°	5560	52°	5670	80
85									11°	4230	33°	4490	43°	4650	49°	4770	85
90											27°	3700	39°	3870	46°	3990	90
95											19°	3000	34°	3180	43°	3300	95
100													29°	2570	39°	2700	100
105													23°	2030	36°	2160	105
110													14°	1530	31°	1680	110
115															26°	1240	115
120															19°	840	120
125																	125
130																	130
DEDUCTIONS FOR MAIN BOOM CAPACITIES	0°	29250	0°	16000	0°	9850	0°	6500	0°	4100	0°	2750	0°	1500	0°	600	
		1570		1140		920		770		660		580		520		460	STOWED
		3510		3240		3100		3010		2940		2890		2850		2820	RET
		3910		3530		3340		3200		3110		3040		2980		2940	EXT
	2620		2420		2320		2250		2200		2170		2140		2120	FIXED	

CODE 7

MAIN BOOM

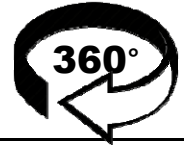

LOAD RADIUS (FT)	ANGLE	LIFTING CAP. (LBS)	ANGLE	LIFTING CAP. (LBS)	ANGLE	LIFTING CAP. (LBS)	ANGLE	LIFTING CAP. (LBS)	ANGLE	LIFTING CAP. (LBS)	ANGLE	LIFTING CAP. (LBS)	ANGLE	LIFTING CAP. (LBS)	ANGLE	LIFTING CAP. (LBS)	LOAD RADIUS (FT)
LENGTH	39.3 FT		53 FT		66 FT		79 FT		92 FT		105 FT		118 FT		131 FT		
6	74°	130000															6
8	70°	120000															8
10	67°	104870	74°	80000	77°	73200											10
12	64°	95630	71°	80000	76°	68990	78°	54510									12
15	59°	84050	68°	74250	73°	62490	76°	49640	79°	38040							15
20	50°	61630	62°	62410	68°	53070	72°	43090	75°	33510	78°	28990					20
25	40°	47660	55°	48650	63°	46050	69°	37560	72°	29440	75°	25810	77°	22810			25
30	26°	36250	49°	37820	58°	38620	65°	33320	69°	26050	72°	23390	75°	20770	77°	18180	30
35			41°	27770	53°	28500	61°	28970	66°	23500	69°	21000	73°	18830	75°	16770	35
40			31°	21310	47°	22030	56°	22460	62°	21000	66°	18910	70°	17110	73°	15360	40
45			18°	16770	41°	17510	52°	17940	58°	18230	63°	17130	67°	15520	70°	14070	45
50					35°	14180	47°	14610	55°	14890	60°	15090	65°	14150	68°	12900	50
55					28°	11580	41°	12050	51°	12320	57°	12520	62°	12670	66°	12100	55
60					18°	9280	35°	9850	46°	10160	54°	10380	59°	10540	63°	10670	60
65							28°	8080	42°	8390	50°	8610	56°	8770	61°	8890	65
70							18°	6610	36°	6950	46°	7160	53°	7320	58°	7440	70
75									30°	5740	42°	5960	50°	6110	55°	6230	75
80									23°	4710	38°	4940	46°	5100	52°	5220	80
85									11°	3810	33°	4070	43°	4230	49°	4340	85
90											27°	3310	39°	3470	46°	3590	90
95											19°	2630	34°	2810	43°	2930	95
100													29°	2230	39°	2350	100
105													23°	1700	36°	1830	105
110													14°	1220	31°	1370	110
115															26°	940	115
120																	120
125																	125
130																	130
DEDUCTIONS FOR MAIN BOOM CAPACITIES	0°	28650	0°	15250	0°	9200	0°	6050	0°	3700	0°	2450	0°	1200	0°	600	
		1570		1140		920		770		660		580		520		460	STOWED
		3510		3240		3100		3010		2940		2890		2850		2820	RET
		3910		3530		3340		3200		3110		3040		2980		2940	EXT
	2620		2420		2320		2250		2200		2170		2140		2120	FIXED	

CODE 8

MAIN BOOM

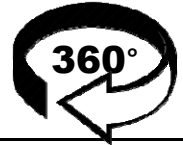

LOAD RADIUS (FT)	ANGLE	LIFTING CAP. (LBS)	ANGLE	LIFTING CAP. (LBS)	ANGLE	LIFTING CAP. (LBS)	ANGLE	LIFTING CAP. (LBS)	ANGLE	LIFTING CAP. (LBS)	ANGLE	LIFTING CAP. (LBS)	ANGLE	LIFTING CAP. (LBS)	ANGLE	LIFTING CAP. (LBS)	LOAD RADIUS (FT)
LENGTH	39.3 FT		53 FT		66 FT		79 FT		92 FT		105 FT		118 FT		131 FT		
6	74°	130000															6
8	70°	120000															8
10	67°	104870	74°	80000	77°	73200											10
12	64°	95630	71°	80000	76°	68990	78°	54510									12
15	59°	83550	68°	74250	73°	62490	76°	49640	79°	38040							15
20	50°	60980	62°	61950	68°	53070	72°	43090	75°	33510	78°	28990					20
25	40°	47140	55°	48130	63°	46050	69°	37560	72°	29440	75°	25810	77°	22810			25
30	26°	34840	49°	36410	58°	37210	65°	33320	69°	26050	72°	23390	75°	20770	77°	18180	30
35			41°	26670	53°	27410	61°	27870	66°	23500	69°	21000	73°	18830	75°	16770	35
40			31°	20410	47°	21130	56°	21560	62°	21000	66°	18910	70°	17110	73°	15360	40
45			18°	16000	41°	16750	52°	17180	58°	17470	63°	17130	67°	15520	70°	14070	45
50					35°	13520	47°	13950	55°	14230	60°	14430	65°	14150	68°	12900	50
55					28°	10830	41°	11320	51°	11630	57°	11850	62°	12020	66°	12100	55
60					18°	8620	35°	9190	46°	9500	54°	9710	59°	9880	63°	10000	60
65							28°	7480	42°	7800	50°	8010	56°	8170	61°	8290	65
70							18°	6070	36°	6410	46°	6620	53°	6780	58°	6900	70
75									30°	5250	42°	5460	50°	5620	55°	5740	75
80									23°	4260	38°	4490	46°	4640	52°	4760	80
85									11°	3380	33°	3650	43°	3800	49°	3920	85
90											27°	2910	39°	3080	46°	3200	90
95											19°	2260	34°	2440	43°	2560	95
100													29°	1880	39°	2000	100
105													23°	1370	36°	1500	105
110													14°	910	31°	1050	110
115																	115
120																	120
125																	125
130																	130
DEDUCTIONS FOR MAIN BOOM CAPACITIES	0°	28000	0°	14550	0°	8550	0°	5600	0°	3300	0°	2150	0°	500	0°	300	
		1570		1140		920		770		660		580		520		460	STOWED
		3510		3240		3100		3010		2940		2890		2850		2820	RET
		3910		3530		3340		3200		3110		3040		2980		2940	EXT
	2620		2420		2320		2250		2200		2170		2140		2120	FIXED	

CODE 9

MAIN BOOM

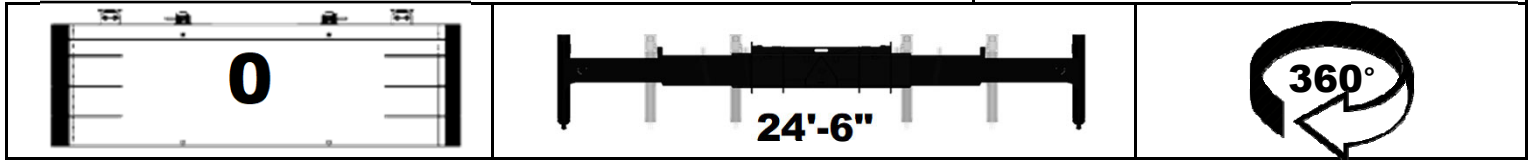

LOAD RADIUS (FT)	ANGLE	LIFTING CAP. (LBS)	ANGLE	LIFTING CAP. (LBS)	ANGLE	LIFTING CAP. (LBS)	ANGLE	LIFTING CAP. (LBS)	ANGLE	LIFTING CAP. (LBS)	ANGLE	LIFTING CAP. (LBS)	ANGLE	LIFTING CAP. (LBS)	ANGLE	LIFTING CAP. (LBS)	LOAD RADIUS (FT)
LENGTH	39.3 FT		53 FT		66 FT		79 FT		92 FT		105 FT		118 FT		131 FT		
6	74°	130000															6
8	70°	120000															8
10	67°	104870	74°	80000	77°	73200											10
12	64°	95630	71°	80000	76°	68990	78°	54510									12
15	59°	82700	68°	74250	73°	62490	76°	49640	79°	38040							15
20	50°	60330	62°	61300	68°	53070	72°	43090	75°	33510	78°	28990					20
25	40°	46610	55°	47600	63°	46050	69°	37560	72°	29440	75°	25810	77°	22810			25
30	26°	33440	49°	35010	58°	35800	65°	33320	69°	26050	72°	23390	75°	20770	77°	18180	30
35			41°	25580	53°	26310	61°	26780	66°	23500	69°	21000	73°	18830	75°	16770	35
40			31°	19510	47°	20230	56°	20670	62°	20970	66°	18910	70°	17110	73°	15360	40
45			18°	15240	41°	15990	52°	16410	58°	16700	63°	16910	67°	15520	70°	14070	45
50					35°	12730	47°	13210	55°	13530	60°	13760	65°	13920	68°	12900	50
55					28°	10080	41°	10570	51°	10880	57°	11100	62°	11270	66°	11400	55
60					18°	7950	35°	8520	46°	8830	54°	9050	59°	9210	63°	9340	60
65							28°	6880	42°	7200	50°	7410	56°	7570	61°	7690	65
70							18°	5530	36°	5860	46°	6080	53°	6230	58°	6350	70
75									30°	4750	42°	4970	50°	5120	55°	5240	75
80									23°	3800	38°	4030	46°	4180	52°	4300	80
85									11°	2960	33°	3220	43°	3380	49°	3500	85
90											27°	2520	39°	2680	46°	2800	90
95											19°	1890	34°	2070	43°	2190	95
100													29°	1530	39°	1650	100
105													23°	1040	36°	1170	105
110																	110
115																	115
120																	120
125																	125
130																	130
DEDUCTIONS FOR MAIN BOOM CAPACITIES	0°	27350	0°	13850	0°	7900	0°	5150	0°	2900	0°	1850	0°	0	0°	0	
		1570		1140		920		770		660		580		520		460	STOWED
		3510		3240		3100		3010		2940		2890		2850		2820	RET
		3910		3530		3340		3200		3110		3040		2980		2940	EXT
	2620		2420		2320		2250		2200		2170		2140		2120	FIXED	

CODE 10

MAIN BOOM



10,000

24'-6"

REAR

LOAD RADIUS (FT)	ANGLE	LIFTING CAP. (LBS)	ANGLE	LIFTING CAP. (LBS)	ANGLE	LIFTING CAP. (LBS)	ANGLE	LIFTING CAP. (LBS)	ANGLE	LIFTING CAP. (LBS)	ANGLE	LIFTING CAP. (LBS)	ANGLE	LIFTING CAP. (LBS)	ANGLE	LIFTING CAP. (LBS)	LOAD RADIUS (FT)
LENGTH		39.3 FT		53 FT		66 FT		79 FT		92 FT		105 FT		118 FT		131 FT	
6	74°	130000															6
8	70°	120000															8
10	67°	104870	74°	80000	77°	73200											10
12	64°	95630	71°	80000	76°	68990	78°	54510									12
15	59°	84050	68°	74250	73°	62490	76°	49640	79°	38040							15
20	50°	65540	62°	62410	68°	53070	72°	43090	75°	33510	78°	28990					20
25	40°	50810	55°	51800	63°	46050	69°	37560	72°	29440	75°	25810	77°	22810			25
30	26°	40810	49°	41860	58°	40230	65°	33320	69°	26050	72°	23390	75°	20770	77°	18180	30
35			41°	34680	53°	35220	61°	29630	66°	23500	69°	21000	73°	18830	75°	16770	35
40			31°	29250	47°	29810	56°	26450	62°	21000	66°	18910	70°	17110	73°	15360	40
45			18°	24140	41°	24840	52°	24040	58°	18920	63°	17130	67°	15520	70°	14070	45
50					35°	20780	47°	21180	55°	17110	60°	15540	65°	14150	68°	12900	50
55					28°	17600	41°	18010	51°	15570	57°	14150	62°	12930	66°	12100	55
60					18°	13960	35°	15480	46°	14210	54°	12920	59°	12100	63°	11110	60
65							28°	13390	42°	13000	50°	12100	56°	11100	61°	10190	65
70							18°	11630	36°	11930	46°	11110	53°	10190	58°	9370	70
75									30°	10460	42°	10190	50°	9360	55°	8620	75
80									23°	9180	38°	9380	46°	8620	52°	7940	80
85									11°	8050	33°	8290	43°	7950	49°	7310	85
90											27°	7320	39°	7300	46°	6740	90
95											19°	6460	34°	6620	43°	6200	95
100													29°	5870	39°	5720	100
105													23°	5180	36°	5250	105
110													14°	4560	31°	4690	110
115															26°	4140	115
120															19°	3630	120
125															6°	3140	125
130																	130
DEDUCTIONS FOR MAIN BOOM CAPACITIES	0°	30700	0°	19750	0°	13750	0°	9100	0°	7350	0°	4500	0°	3750	0°	600	
		1570		1140		920		770		660		580		520		460	STOWED
		3510		3240		3100		3010		2940		2890		2850		2820	RET
		3910		3530		3340		3200		3110		3040		2980		2940	EXT
	2620		2420		2320		2250		2200		2170		2140		2120	FIXED	

CODE 11

MAIN BOOM

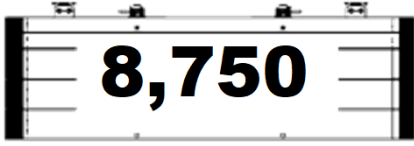

LOAD RADIUS (FT)	ANGLE	LIFTING CAP. (LBS)	ANGLE	LIFTING CAP. (LBS)	ANGLE	LIFTING CAP. (LBS)	ANGLE	LIFTING CAP. (LBS)	ANGLE	LIFTING CAP. (LBS)	ANGLE	LIFTING CAP. (LBS)	ANGLE	LIFTING CAP. (LBS)	ANGLE	LIFTING CAP. (LBS)	LOAD RADIUS (FT)
LENGTH	39.3 FT		53 FT		66 FT		79 FT		92 FT		105 FT		118 FT		131 FT		
6	74°	130000															6
8	70°	120000															8
10	67°	104870	74°	80000	77°	73200											10
12	64°	95630	71°	80000	76°	68990	78°	54510									12
15	59°	84050	68°	74250	73°	62490	76°	49640	79°	38040							15
20	50°	64890	62°	62410	68°	53070	72°	43090	75°	33510	78°	28990					20
25	40°	50280	55°	51280	63°	46050	69°	37560	72°	29440	75°	25810	77°	22810			25
30	26°	40370	49°	41420	58°	40230	65°	33320	69°	26050	72°	23390	75°	20770	77°	18180	30
35			41°	34310	53°	34840	61°	29630	66°	23500	69°	21000	73°	18830	75°	16770	35
40			31°	28830	47°	29470	56°	26450	62°	21000	66°	18910	70°	17110	73°	15360	40
45			18°	23500	41°	24190	52°	24040	58°	18920	63°	17130	67°	15520	70°	14070	45
50					35°	20210	47°	20610	55°	17110	60°	15540	65°	14150	68°	12900	50
55					28°	17100	41°	17510	51°	15570	57°	14150	62°	12930	66°	12100	55
60					18°	13960	35°	15030	46°	14210	54°	12920	59°	12100	63°	11110	60
65							28°	12980	42°	13000	50°	12100	56°	11100	61°	10190	65
70							18°	11260	36°	11550	46°	11110	53°	10190	58°	9370	70
75									30°	10110	42°	10190	50°	9360	55°	8620	75
80									23°	8860	38°	9060	46°	8620	52°	7940	80
85									11°	7750	33°	7990	43°	7950	49°	7310	85
90											27°	7040	39°	7190	46°	6740	90
95											19°	6200	34°	6360	43°	6200	95
100													29°	5620	39°	5720	100
105													23°	4950	36°	5060	105
110													14°	4330	31°	4470	110
115															26°	3920	115
120															19°	3420	120
125															6°	2940	125
130																	130
DEDUCTIONS FOR MAIN BOOM CAPACITIES	0°	30500	0°	19400	0°	13750	0°	8950	0°	7150	0°	4450	0°	3600	0°	600	
		1570		1140		920		770		660		580		520		460	STOWED
		3510		3240		3100		3010		2940		2890		2850		2820	RET
		3910		3530		3340		3200		3110		3040		2980		2940	EXT
	2620		2420		2320		2250		2200		2170		2140		2120	FIXED	

CODE 12

MAIN BOOM

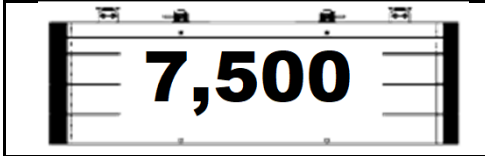

LOAD RADIUS (FT)	ANGLE	LIFTING CAP. (LBS)	ANGLE	LIFTING CAP. (LBS)	ANGLE	LIFTING CAP. (LBS)	ANGLE	LIFTING CAP. (LBS)	ANGLE	LIFTING CAP. (LBS)	ANGLE	LIFTING CAP. (LBS)	ANGLE	LIFTING CAP. (LBS)	ANGLE	LIFTING CAP. (LBS)	LOAD RADIUS (FT)
LENGTH	39.3 FT		53 FT		66 FT		79 FT		92 FT		105 FT		118 FT		131 FT		
6	74°	130000															6
8	70°	120000															8
10	67°	104870	74°	80000	77°	73200											10
12	64°	95630	71°	80000	76°	68990	78°	54510									12
15	59°	84050	68°	74250	73°	62490	76°	49640	79°	38040							15
20	50°	64240	62°	62410	68°	53070	72°	43090	75°	33510	78°	28990					20
25	40°	49760	55°	50750	63°	46050	69°	37560	72°	29440	75°	25810	77°	22810			25
30	26°	39930	49°	40980	58°	40230	65°	33320	69°	26050	72°	23390	75°	20770	77°	18180	30
35			41°	33930	53°	34460	61°	29630	66°	23500	69°	21000	73°	18830	75°	16770	35
40			31°	28070	47°	28730	56°	26450	62°	21000	66°	18910	70°	17110	73°	15360	40
45			18°	22850	41°	23550	52°	23940	58°	18920	63°	17130	67°	15520	70°	14070	45
50					35°	19650	47°	20050	55°	17110	60°	15540	65°	14150	68°	12900	50
55					28°	16600	41°	17010	51°	15570	57°	14150	62°	12930	66°	12100	55
60					18°	13960	35°	14570	46°	14210	54°	12920	59°	12100	63°	11110	60
65							28°	12570	42°	12840	50°	12100	56°	11100	61°	10190	65
70							18°	10880	36°	11180	46°	11110	53°	10190	58°	9370	70
75									30°	9760	42°	9950	50°	9360	55°	8620	75
80									23°	8540	38°	8740	46°	8620	52°	7940	80
85									11°	7450	33°	7690	43°	7830	49°	7310	85
90											27°	6760	39°	6910	46°	6740	90
95											19°	5930	34°	6090	43°	6200	95
100													29°	5360	39°	5480	100
105													23°	4710	36°	4830	105
110													14°	4100	31°	4240	110
115															26°	3710	115
120															19°	3210	120
125															6°	2740	125
130																	130
DEDUCTIONS FOR MAIN BOOM CAPACITIES	0°	30300	0°	19050	0°	13750	0°	8800	0°	6900	0°	4450	0°	3450	0°	600	
		1570		1140		920		770		660		580		520		460	STOWED
		3510		3240		3100		3010		2940		2890		2850		2820	RET
		3910		3530		3340		3200		3110		3040		2980		2940	EXT
	2620		2420		2320		2250		2200		2170		2140		2120	FIXED	

CODE 13

MAIN BOOM

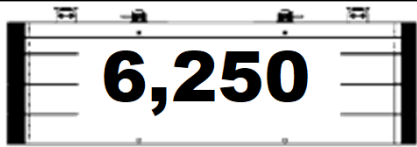

LOAD RADIUS (FT)	ANGLE	LIFTING CAP. (LBS)	ANGLE	LIFTING CAP. (LBS)	ANGLE	LIFTING CAP. (LBS)	ANGLE	LIFTING CAP. (LBS)	ANGLE	LIFTING CAP. (LBS)	ANGLE	LIFTING CAP. (LBS)	ANGLE	LIFTING CAP. (LBS)	ANGLE	LIFTING CAP. (LBS)	LOAD RADIUS (FT)
LENGTH	39.3 FT		53 FT		66 FT		79 FT		92 FT		105 FT		118 FT		131 FT		
6	74°	130000															6
8	70°	120000															8
10	67°	104870	74°	80000	77°	73200											10
12	64°	95630	71°	80000	76°	68990	78°	54510									12
15	59°	84050	68°	74250	73°	62490	76°	49640	79°	38040							15
20	50°	63580	62°	62410	68°	53070	72°	43090	75°	33510	78°	28990					20
25	40°	49240	55°	50230	63°	46050	69°	37560	72°	29440	75°	25810	77°	22810			25
30	26°	39490	49°	40540	58°	40230	65°	33320	69°	26050	72°	23390	75°	20770	77°	18180	30
35			41°	33550	53°	34080	61°	29630	66°	23500	69°	21000	73°	18830	75°	16770	35
40			31°	27320	47°	27970	56°	26450	62°	21000	66°	18910	70°	17110	73°	15360	40
45			18°	22200	41°	22900	52°	23300	58°	18920	63°	17130	67°	15520	70°	14070	45
50					35°	19080	47°	19480	55°	17110	60°	15540	65°	14150	68°	12900	50
55					28°	16090	41°	16510	51°	15570	57°	14150	62°	12930	66°	12100	55
60					18°	13630	35°	14120	46°	14210	54°	12920	59°	12100	63°	11110	60
65							28°	12160	42°	12430	50°	12100	56°	11100	61°	10190	65
70							18°	10500	36°	10800	46°	10990	53°	10190	58°	9370	70
75									30°	9410	42°	9600	50°	9360	55°	8620	75
80									23°	8210	38°	8420	46°	8550	52°	7940	80
85									11°	7150	33°	7390	43°	7530	49°	7310	85
90											27°	6480	39°	6620	46°	6730	90
95											19°	5660	34°	5830	43°	5930	95
100													29°	5110	39°	5220	100
105													23°	4470	36°	4590	105
110													14°	3880	31°	4010	110
115															26°	3490	115
120															19°	3010	120
125															6°	2550	125
130																	130
DEDUCTIONS FOR MAIN BOOM CAPACITIES	0°	30100	0°	18650	0°	13400	0°	8700	0°	6700	0°	4400	0°	3350	0°	600	
		1570		1140		920		770		660		580		520		460	STOWED
		3510		3240		3100		3010		2940		2890		2850		2820	RET
		3910		3530		3340		3200		3110		3040		2980		2940	EXT
	2620		2420		2320		2250		2200		2170		2140		2120	FIXED	

CODE 14

MAIN BOOM

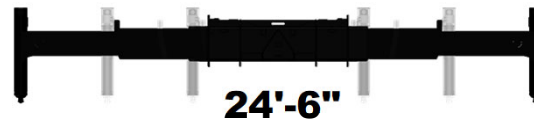

LOAD RADIUS (FT)	ANGLE	LIFTING CAP. (LBS)	ANGLE	LIFTING CAP. (LBS)	ANGLE	LIFTING CAP. (LBS)	ANGLE	LIFTING CAP. (LBS)	ANGLE	LIFTING CAP. (LBS)	ANGLE	LIFTING CAP. (LBS)	ANGLE	LIFTING CAP. (LBS)	ANGLE	LIFTING CAP. (LBS)	LOAD RADIUS (FT)
LENGTH	39.3 FT		53 FT		66 FT		79 FT		92 FT		105 FT		118 FT		131 FT		
6	74°	130000															6
8	70°	120000															8
10	67°	104870	74°	80000	77°	73200											10
12	64°	95630	71°	80000	76°	68990	78°	54510									12
15	59°	84050	68°	74250	73°	62490	76°	49640	79°	38040							15
20	50°	62930	62°	62410	68°	53070	72°	43090	75°	33510	78°	28990					20
25	40°	48710	55°	49700	63°	46050	69°	37560	72°	29440	75°	25810	77°	22810			25
30	26°	39050	49°	40100	58°	40230	65°	33320	69°	26050	72°	23390	75°	20770	77°	18180	30
35			41°	33170	53°	33710	61°	29630	66°	23500	69°	21000	73°	18830	75°	16770	35
40			31°	26560	47°	27220	56°	26450	62°	21000	66°	18910	70°	17110	73°	15360	40
45			18°	21560	41°	22250	52°	22650	58°	18920	63°	17130	67°	15520	70°	14070	45
50					35°	18520	47°	18910	55°	17110	60°	15540	65°	14150	68°	12900	50
55					28°	15590	41°	16000	51°	15570	57°	14150	62°	12930	66°	12100	55
60					18°	13170	35°	13670	46°	13930	54°	12920	59°	12100	63°	11110	60
65							28°	11750	42°	12020	50°	12100	56°	11100	61°	10190	65
70							18°	10130	36°	10420	46°	10610	53°	10190	58°	9370	70
75									30°	9060	42°	9260	50°	9360	55°	8620	75
80									23°	7890	38°	8090	46°	8230	52°	7940	80
85									11°	6850	33°	7080	43°	7220	49°	7310	85
90											27°	6190	39°	6340	46°	6450	90
95											19°	5400	34°	5560	43°	5670	95
100													29°	4860	39°	4970	100
105													23°	4230	36°	4350	105
110													14°	3650	31°	3790	110
115															26°	3280	115
120															19°	2800	120
125															6°	2350	125
130																	130
DEDUCTIONS FOR MAIN BOOM CAPACITIES	0°	29900	0°	18300	0°	13000	0°	8550	0°	6450	0°	4350	0°	3200	0°	600	
		1570		1140		920		770		660		580		520		460	STOWED
		3510		3240		3100		3010		2940		2890		2850		2820	RET
		3910		3530		3340		3200		3110		3040		2980		2940	EXT
	2620		2420		2320		2250		2200		2170		2140		2120	FIXED	

CODE 15

MAIN BOOM

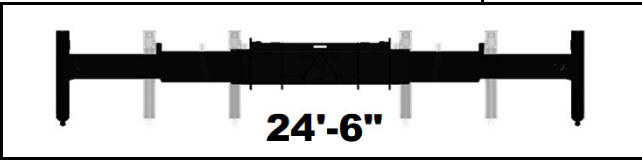
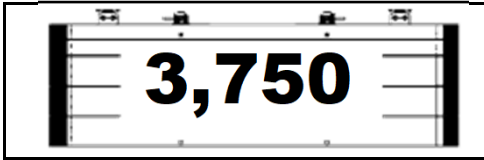

LOAD RADIUS (FT)	ANGLE	LIFTING CAP. (LBS)	ANGLE	LIFTING CAP. (LBS)	ANGLE	LIFTING CAP. (LBS)	ANGLE	LIFTING CAP. (LBS)	ANGLE	LIFTING CAP. (LBS)	ANGLE	LIFTING CAP. (LBS)	ANGLE	LIFTING CAP. (LBS)	ANGLE	LIFTING CAP. (LBS)	LOAD RADIUS (FT)
LENGTH	39.3 FT		53 FT		66 FT		79 FT		92 FT		105 FT		118 FT		131 FT		
6	74°	130000															6
8	70°	120000															8
10	67°	104870	74°	80000	77°	73200											10
12	64°	95630	71°	80000	76°	68990	78°	54510									12
15	59°	84050	68°	74250	73°	62490	76°	49640	79°	38040							15
20	50°	62280	62°	62410	68°	53070	72°	43090	75°	33510	78°	28990					20
25	40°	48190	55°	49180	63°	46050	69°	37560	72°	29440	75°	25810	77°	22810			25
30	26°	38610	49°	39660	58°	40180	65°	33320	69°	26050	72°	23390	75°	20770	77°	18180	30
35			41°	32590	53°	33250	61°	29630	66°	23500	69°	21000	73°	18830	75°	16770	35
40			31°	25810	47°	26470	56°	26450	62°	21000	66°	18910	70°	17110	73°	15360	40
45			18°	20910	41°	21610	52°	22000	58°	18920	63°	17130	67°	15520	70°	14070	45
50					35°	17950	47°	18350	55°	17110	60°	15540	65°	14150	68°	12900	50
55					28°	15090	41°	15500	51°	15570	57°	14150	62°	12930	66°	12100	55
60					18°	12720	35°	13220	46°	13480	54°	12920	59°	12100	63°	11110	60
65							28°	11340	42°	11610	50°	11790	56°	11100	61°	10190	65
70							18°	9750	36°	10050	46°	10230	53°	10190	58°	9370	70
75									30°	8720	42°	8910	50°	9040	55°	8620	75
80									23°	7570	38°	7770	46°	7910	52°	7940	80
85									11°	6550	33°	6780	43°	6920	49°	7030	85
90											27°	5910	39°	6060	46°	6160	90
95											19°	5130	34°	5290	43°	5400	95
100													29°	4610	39°	4720	100
105													23°	3990	36°	4110	105
110													14°	3430	31°	3560	110
115															26°	3060	115
120															19°	2600	120
125															6°	2150	125
130																	130
DEDUCTIONS FOR MAIN BOOM CAPACITIES	0°	29700	0°	17950	0°	12550	0°	8400	0°	6250	0°	4300	0°	3100	0°	600	
		1570		1140		920		770		660		580		520		460	STOWED
		3510		3240		3100		3010		2940		2890		2850		2820	RET
		3910		3530		3340		3200		3110		3040		2980		2940	EXT
	2620		2420		2320		2250		2200		2170		2140		2120	FIXED	

CODE 16

MAIN BOOM

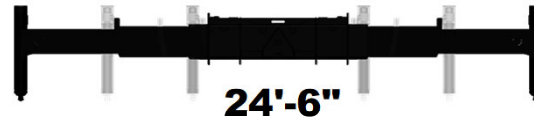

LOAD RADIUS (FT)	ANGLE	LIFTING CAP. (LBS)	ANGLE	LIFTING CAP. (LBS)	ANGLE	LIFTING CAP. (LBS)	ANGLE	LIFTING CAP. (LBS)	ANGLE	LIFTING CAP. (LBS)	ANGLE	LIFTING CAP. (LBS)	ANGLE	LIFTING CAP. (LBS)	ANGLE	LIFTING CAP. (LBS)	LOAD RADIUS (FT)
LENGTH	39.3 FT		53 FT		66 FT		79 FT		92 FT		105 FT		118 FT		131 FT		
6	74°	130000															6
8	70°	120000															8
10	67°	104870	74°	80000	77°	73200											10
12	64°	95630	71°	80000	76°	68990	78°	54510									12
15	59°	84050	68°	74250	73°	62490	76°	49640	79°	38040							15
20	50°	61630	62°	62410	68°	53070	72°	43090	75°	33510	78°	28990					20
25	40°	47660	55°	48650	63°	46050	69°	37560	72°	29440	75°	25810	77°	22810			25
30	26°	38170	49°	39220	58°	39740	65°	33320	69°	26050	72°	23390	75°	20770	77°	18180	30
35			41°	31680	53°	32350	61°	29630	66°	23500	69°	21000	73°	18830	75°	16770	35
40			31°	25060	47°	25710	56°	26110	62°	21000	66°	18910	70°	17110	73°	15360	40
45			18°	20270	41°	20960	52°	21360	58°	18920	63°	17130	67°	15520	70°	14070	45
50					35°	17390	47°	17780	55°	17110	60°	15540	65°	14150	68°	12900	50
55					28°	14590	41°	15000	51°	15260	57°	14150	62°	12930	66°	12100	55
60					18°	12270	35°	12760	46°	13030	54°	12920	59°	12100	63°	11110	60
65							28°	10920	42°	11200	50°	11380	56°	11100	61°	10190	65
70							18°	9370	36°	9670	46°	9850	53°	9990	58°	9370	70
75									30°	8370	42°	8560	50°	8700	55°	8620	75
80									23°	7240	38°	7450	46°	7590	52°	7690	80
85									11°	6250	33°	6480	43°	6620	49°	6720	85
90											27°	5630	39°	5780	46°	5880	90
95											19°	4870	34°	5030	43°	5130	95
100													29°	4360	39°	4470	100
105													23°	3760	36°	3870	105
110													14°	3200	31°	3340	110
115															26°	2840	115
120															19°	2390	120
125															6°	1960	125
130																	130
DEDUCTIONS FOR MAIN BOOM CAPACITIES	0°	29500	0°	17600	0°	12150	0°	8300	0°	6000	0°	4250	0°	2950	0°	600	
		1570		1140		920		770		660		580		520		460	STOWED
		3510		3240		3100		3010		2940		2890		2850		2820	RET
		3910		3530		3340		3200		3110		3040		2980		2940	EXT
	2620		2420		2320		2250		2200		2170		2140		2120	FIXED	

CODE 17

MAIN BOOM



LOAD RADIUS (FT)	ANGLE	LIFTING CAP. (LBS)	ANGLE	LIFTING CAP. (LBS)	ANGLE	LIFTING CAP. (LBS)	ANGLE	LIFTING CAP. (LBS)	ANGLE	LIFTING CAP. (LBS)	ANGLE	LIFTING CAP. (LBS)	ANGLE	LIFTING CAP. (LBS)	ANGLE	LIFTING CAP. (LBS)	LOAD RADIUS (FT)
LENGTH	39.3 FT		53 FT		66 FT		79 FT		92 FT		105 FT		118 FT		131 FT		
6	74°	130000															6
8	70°	120000															8
10	67°	104870	74°	80000	77°	73200											10
12	64°	95630	71°	80000	76°	68990	78°	54510									12
15	59°	83550	68°	74250	73°	62490	76°	49640	79°	38040							15
20	50°	60980	62°	61950	68°	53070	72°	43090	75°	33510	78°	28990					20
25	40°	47140	55°	48130	63°	46050	69°	37560	72°	29440	75°	25810	77°	22810			25
30	26°	37730	49°	38780	58°	39310	65°	33320	69°	26050	72°	23390	75°	20770	77°	18180	30
35			41°	30780	53°	31440	61°	29630	66°	23500	69°	21000	73°	18830	75°	16770	35
40			31°	24300	47°	24960	56°	25360	62°	21000	66°	18910	70°	17110	73°	15360	40
45			18°	19620	41°	20320	52°	20710	58°	18920	63°	17130	67°	15520	70°	14070	45
50					35°	16820	47°	17220	55°	17110	60°	15540	65°	14150	68°	12900	50
55					28°	14080	41°	14500	51°	14760	57°	14150	62°	12930	66°	12100	55
60					18°	11820	35°	12310	46°	12580	54°	12760	59°	12100	63°	11110	60
65							28°	10510	42°	10790	50°	10970	56°	11100	61°	10190	65
70							18°	9000	36°	9290	46°	9480	53°	9610	58°	9370	70
75									30°	8020	42°	8210	50°	8350	55°	8450	75
80									23°	6920	38°	7130	46°	7260	52°	7360	80
85									11°	5940	33°	6180	43°	6320	49°	6420	85
90											27°	5350	39°	5490	46°	5600	90
95											19°	4600	34°	4760	43°	4870	95
100													29°	4110	39°	4220	100
105													23°	3520	36°	3640	105
110													14°	2970	31°	3110	110
115															26°	2630	115
120															19°	2190	120
125															6°	1760	125
130																	130
DEDUCTIONS FOR MAIN BOOM CAPACITIES	0°	29300	0°	17250	0°	11700	0°	8150	0°	5700	0°	4000	0°	2750	0°	400	
		1570		1140		920		770		660		580		520		460	STOWED
		3510		3240		3100		3010		2940		2890		2850		2820	RET
		3910		3530		3340		3200		3110		3040		2980		2940	EXT
	2620		2420		2320		2250		2200		2170		2140		2120	FIXED	

CODE 18

MAIN BOOM

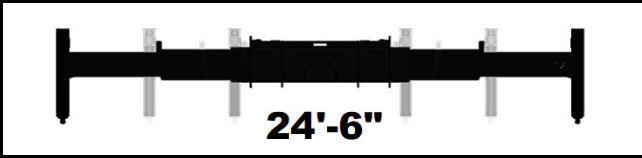
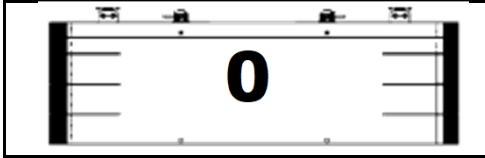

LOAD RADIUS (FT)	ANGLE	LIFTING CAP. (LBS)	ANGLE	LIFTING CAP. (LBS)	ANGLE	LIFTING CAP. (LBS)	ANGLE	LIFTING CAP. (LBS)	ANGLE	LIFTING CAP. (LBS)	ANGLE	LIFTING CAP. (LBS)	ANGLE	LIFTING CAP. (LBS)	ANGLE	LIFTING CAP. (LBS)	LOAD RADIUS (FT)
LENGTH	39.3 FT		53 FT		66 FT		79 FT		92 FT		105 FT		118 FT		131 FT		
6	74°	130000															6
8	70°	120000															8
10	67°	104870	74°	80000	77°	73200											10
12	64°	95630	71°	80000	76°	68990	78°	54510									12
15	59°	82700	68°	74250	73°	62490	76°	49640	79°	38040							15
20	50°	60330	62°	61300	68°	53070	72°	43090	75°	33510	78°	28990					20
25	40°	46610	55°	47600	63°	46050	69°	37560	72°	29440	75°	25810	77°	22810			25
30	26°	37290	49°	38340	58°	38870	65°	33320	69°	26050	72°	23390	75°	20770	77°	18180	30
35			41°	29870	53°	30540	61°	29630	66°	23500	69°	21000	73°	18830	75°	16770	35
40			31°	23550	47°	24200	56°	24610	62°	21000	66°	18910	70°	17110	73°	15360	40
45			18°	18970	41°	19670	52°	20060	58°	18920	63°	17130	67°	15520	70°	14070	45
50					35°	16260	47°	16650	55°	16910	60°	15540	65°	14150	68°	12900	50
55					28°	13580	41°	13990	51°	14250	57°	14150	62°	12930	66°	12100	55
60					18°	11360	35°	11860	46°	12120	54°	12310	59°	12100	63°	11110	60
65							28°	10100	42°	10380	50°	10560	56°	10690	61°	10190	65
70							18°	8620	36°	8910	46°	9100	53°	9230	58°	9340	70
75									30°	7670	42°	7860	50°	8000	55°	8100	75
80									23°	6600	38°	6800	46°	6940	52°	7040	80
85									11°	5640	33°	5880	43°	6020	49°	6120	85
90											27°	5060	39°	5210	46°	5310	90
95											19°	4330	34°	4500	43°	4600	95
100													29°	3860	39°	3970	100
105													23°	3280	36°	3400	105
110													14°	2750	31°	2880	110
115															26°	2410	115
120															19°	1980	120
125															6°	1560	125
130																	130
DEDUCTIONS FOR MAIN BOOM CAPACITIES	0°	29100	0°	16900	0°	11250	0°	7750	0°	5400	0°	3750	0°	2500	0°	400	
		1570		1140		920		770		660		580		520		460	STOWED
		3510		3240		3100		3010		2940		2890		2850		2820	RET
		3910		3530		3340		3200		3110		3040		2980		2940	EXT
	2620		2420		2320		2250		2200		2170		2140		2120	FIXED	

CODE 19

MAIN BOOM



10,000

20'-0"

360°

LOAD RADIUS (FT)	ANGLE	LIFTING CAP. (LBS)	ANGLE	LIFTING CAP. (LBS)	ANGLE	LIFTING CAP. (LBS)	ANGLE	LIFTING CAP. (LBS)	ANGLE	LIFTING CAP. (LBS)	ANGLE	LIFTING CAP. (LBS)	ANGLE	LIFTING CAP. (LBS)	ANGLE	LIFTING CAP. (LBS)	LOAD RADIUS (FT)
LENGTH	39.3 FT		53 FT		66 FT		79 FT		92 FT		105 FT		118 FT		131 FT		
6	74°	130000															6
8	70°	120000															8
10	67°	104870	74°	80000	77°	73200											10
12	64°	95630	71°	80000	76°	68990	78°	54510									12
15	59°	84050	68°	74250	73°	62490	76°	49640	79°	38040							15
20	50°	65540	62°	62410	68°	53070	72°	43090	75°	33510	78°	28990					20
25	40°	42660	55°	44110	63°	44890	69°	37560	72°	29440	75°	25810	77°	22810			25
30	26°	29650	49°	31020	58°	31720	65°	32170	69°	26050	72°	23390	75°	20770	77°	18180	30
35			41°	23160	53°	23820	61°	24240	66°	23500	69°	21000	73°	18830	75°	16770	35
40			31°	17890	47°	18540	56°	18950	62°	19220	66°	18910	70°	17110	73°	15360	40
45			18°	14080	41°	14770	52°	15160	58°	15430	63°	15630	67°	15520	70°	14070	45
50					35°	11930	47°	12320	55°	12590	60°	12770	65°	12920	68°	12900	50
55					28°	9700	41°	10110	51°	10370	57°	10560	62°	10690	66°	10800	55
60					18°	7840	35°	8330	46°	8600	54°	8780	59°	8910	63°	9020	60
65							28°	6870	42°	7140	50°	7320	56°	7460	61°	7560	65
70							18°	5630	36°	5920	46°	6110	53°	6240	58°	6350	70
75									30°	4890	42°	5080	50°	5210	55°	5320	75
80									23°	3990	38°	4190	46°	4330	52°	4430	80
85									11°	3190	33°	3420	43°	3560	49°	3670	85
90											27°	2740	39°	2890	46°	2990	90
95											19°	2130	34°	2290	43°	2400	95
100													29°	1760	39°	1870	100
105													23°	1280	36°	1390	105
110													14°	830	31°	960	110
115																	115
120																	120
125																	125
130																	130
DEDUCTIONS FOR MAIN BOOM CAPACITIES	0°	25300	0°	12800	0°	7750	0°	4900	0°	3000	0°	1650	0°	650	0°	600	
		1570		1140		920		770		660		580		520		460	STOWED
		3510		3240		3100		3010		2940		2890		2850		2820	RET
		3910		3530		3340		3200		3110		3040		2980		2940	EXT
	2620		2420		2320		2250		2200		2170		2140		2120	FIXED	

CODE 20

MAIN BOOM



8,750

20'-0"

360°

LOAD RADIUS (FT)	ANGLE	LIFTING CAP. (LBS)	ANGLE	LIFTING CAP. (LBS)	ANGLE	LIFTING CAP. (LBS)	ANGLE	LIFTING CAP. (LBS)	ANGLE	LIFTING CAP. (LBS)	ANGLE	LIFTING CAP. (LBS)	ANGLE	LIFTING CAP. (LBS)	ANGLE	LIFTING CAP. (LBS)	LOAD RADIUS (FT)
LENGTH		39.3 FT		53 FT		66 FT		79 FT		92 FT		105 FT		118 FT		131 FT	
6	74°	130000															6
8	70°	120000															8
10	67°	104870	74°	80000	77°	73200											10
12	64°	95630	71°	80000	76°	68990	78°	54510									12
15	59°	84050	68°	74250	73°	62490	76°	49640	79°	38040							15
20	50°	64890	62°	62410	68°	53070	72°	43090	75°	33510	78°	28990					20
25	40°	41220	55°	42670	63°	43450	69°	37560	72°	29440	75°	25810	77°	22810			25
30	26°	28560	49°	29940	58°	30640	65°	31090	69°	26050	72°	23390	75°	20770	77°	18180	30
35			41°	22290	53°	22950	61°	23370	66°	23500	69°	21000	73°	18830	75°	16770	35
40			31°	17170	47°	17820	56°	18230	62°	18500	66°	18710	70°	17110	73°	15360	40
45			18°	13460	41°	14150	52°	14550	58°	14810	63°	15010	67°	15160	70°	14070	45
50					35°	11390	47°	11780	55°	12050	60°	12230	65°	12380	68°	12490	50
55					28°	9220	41°	9630	51°	9890	57°	10080	62°	10210	66°	10320	55
60					18°	7410	35°	7900	46°	8160	54°	8350	59°	8480	63°	8590	60
65							28°	6470	42°	6750	50°	6930	56°	7070	61°	7170	65
70							18°	5270	36°	5560	46°	5750	53°	5880	58°	5990	70
75									30°	4550	42°	4750	50°	4880	55°	4980	75
80									23°	3680	38°	3880	46°	4020	52°	4120	80
85									11°	2900	33°	3130	43°	3280	49°	3380	85
90											27°	2470	39°	2620	46°	2720	90
95											19°	1880	34°	2040	43°	2150	95
100													29°	1520	39°	1630	100
105													23°	1050	36°	1170	105
110																	110
115																	115
120																	120
125																	125
130																	130
DEDUCTIONS FOR MAIN BOOM CAPACITIES	0°	24350	0°	12200	0°	7300	0°	4600	0°	2700	0°	1400	0°	350	0°	0	
		1570		1140		920		770		660		580		520		460	STOWED
		3510		3240		3100		3010		2940		2890		2850		2820	RET
		3910		3530		3340		3200		3110		3040		2980		2940	EXT
	2620		2420		2320		2250		2200		2170		2140		2120	FIXED	

CODE 21

MAIN BOOM



LOAD RADIUS (FT)	ANGLE	LIFTING CAP. (LBS)	ANGLE	LIFTING CAP. (LBS)	ANGLE	LIFTING CAP. (LBS)	ANGLE	LIFTING CAP. (LBS)	ANGLE	LIFTING CAP. (LBS)	ANGLE	LIFTING CAP. (LBS)	ANGLE	LIFTING CAP. (LBS)	ANGLE	LIFTING CAP. (LBS)	LOAD RADIUS (FT)
LENGTH	39.3 FT		53 FT		66 FT		79 FT		92 FT		105 FT		118 FT		131 FT		
6	74°	130000															6
8	70°	120000															8
10	67°	104870	74°	80000	77°	73200											10
12	64°	95630	71°	80000	76°	68990	78°	54510									12
15	59°	84050	68°	74250	73°	62490	76°	49640	79°	38040							15
20	50°	64240	62°	62410	68°	53070	72°	43090	75°	33510	78°	28990					20
25	40°	39770	55°	41230	63°	42010	69°	37560	72°	29440	75°	25810	77°	22810			25
30	26°	27480	49°	28860	58°	29560	65°	30010	69°	26050	72°	23390	75°	20770	77°	18180	30
35			41°	21430	53°	22090	61°	22510	66°	22800	69°	21000	73°	18830	75°	16770	35
40			31°	16450	47°	17100	56°	17510	62°	17780	66°	17990	70°	17110	73°	15360	40
45			18°	12840	41°	13540	52°	13930	58°	14200	63°	14390	67°	14540	70°	14070	45
50					35°	10850	47°	11240	55°	11510	60°	11690	65°	11840	68°	11950	50
55					28°	8740	41°	9150	51°	9410	57°	9600	62°	9730	66°	9840	55
60					18°	6980	35°	7470	46°	7730	54°	7920	59°	8050	63°	8160	60
65							28°	6080	42°	6350	50°	6540	56°	6670	61°	6780	65
70							18°	4910	36°	5200	46°	5390	53°	5520	58°	5630	70
75									30°	4220	42°	4410	50°	4550	55°	4650	75
80									23°	3370	38°	3580	46°	3710	52°	3820	80
85									11°	2610	33°	2850	43°	2990	49°	3090	85
90											27°	2200	39°	2350	46°	2450	90
95											19°	1620	34°	1790	43°	1890	95
100													29°	1280	39°	1390	100
105													23°	820	36°	940	105
110																	110
115																	115
120																	120
125																	125
130																	130
DEDUCTIONS FOR MAIN BOOM CAPACITIES	0°	23350	0°	11650	0°	6900	0°	4250	0°	2450	0°	1150	0°	100	0°	0	
		1570		1140		920		770		660		580		520		460	STOWED
		3510		3240		3100		3010		2940		2890		2850		2820	RET
		3910		3530		3340		3200		3110		3040		2980		2940	EXT
	2620		2420		2320		2250		2200		2170		2140		2120	FIXED	

CODE 22

MAIN BOOM

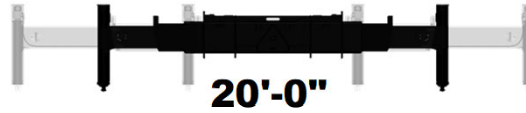
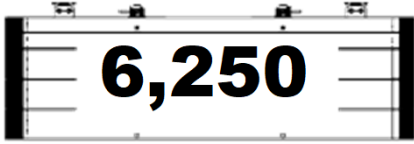

LOAD RADIUS (FT)	ANGLE	LIFTING CAP. (LBS)	ANGLE	LIFTING CAP. (LBS)	ANGLE	LIFTING CAP. (LBS)	ANGLE	LIFTING CAP. (LBS)	ANGLE	LIFTING CAP. (LBS)	ANGLE	LIFTING CAP. (LBS)	ANGLE	LIFTING CAP. (LBS)	ANGLE	LIFTING CAP. (LBS)	LOAD RADIUS (FT)
LENGTH	39.3 FT		53 FT		66 FT		79 FT		92 FT		105 FT		118 FT		131 FT		
6	74°	130000															6
8	70°	120000															8
10	67°	104870	74°	80000	77°	73200											10
12	64°	95630	71°	80000	76°	68990	78°	54510									12
15	59°	84050	68°	74250	73°	62490	76°	49640	79°	38040							15
20	50°	62080	62°	62410	68°	53070	72°	43090	75°	33510	78°	28990					20
25	40°	38330	55°	39790	63°	40560	69°	37560	72°	29440	75°	25810	77°	22810			25
30	26°	26400	49°	27780	58°	28480	65°	28930	69°	26050	72°	23390	75°	20770	77°	18180	30
35			41°	20560	53°	21220	61°	21640	66°	21940	69°	21000	73°	18830	75°	16770	35
40			31°	15730	47°	16380	56°	16790	62°	17060	66°	17270	70°	17110	73°	15360	40
45			18°	12230	41°	12920	52°	13310	58°	13580	63°	13770	67°	13920	70°	14040	45
50					35°	10310	47°	10700	55°	10970	60°	11150	65°	11300	68°	11410	50
55					28°	8260	41°	8670	51°	8930	57°	9120	62°	9250	66°	9360	55
60					18°	6550	35°	7040	46°	7300	54°	7480	59°	7620	63°	7720	60
65							28°	5690	42°	5960	50°	6150	56°	6280	61°	6380	65
70							18°	4550	36°	4840	46°	5030	53°	5160	58°	5270	70
75									30°	3890	42°	4080	50°	4220	55°	4320	75
80									23°	3060	38°	3270	46°	3410	52°	3510	80
85									11°	2330	33°	2560	43°	2700	49°	2800	85
90											27°	1930	39°	2080	46°	2180	90
95											19°	1370	34°	1530	43°	1640	95
100													29°	1040	39°	1150	100
105																	105
110																	110
115																	115
120																	120
125																	125
130																	130
DEDUCTIONS FOR MAIN BOOM CAPACITIES	0°	22400	0°	11050	0°	6450	0°	3900	0°	2150	0°	900	0°	0	0°	0	
		1570		1140		920		770		660		580		520		460	STOWED
		3510		3240		3100		3010		2940		2890		2850		2820	RET
		3910		3530		3340		3200		3110		3040		2980		2940	EXT
	2620		2420		2320		2250		2200		2170		2140		2120	FIXED	

CODE 23

MAIN BOOM

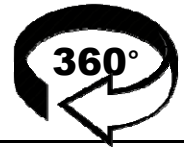

LOAD RADIUS (FT)	ANGLE	LIFTING CAP. (LBS)	ANGLE	LIFTING CAP. (LBS)	ANGLE	LIFTING CAP. (LBS)	ANGLE	LIFTING CAP. (LBS)	ANGLE	LIFTING CAP. (LBS)	ANGLE	LIFTING CAP. (LBS)	ANGLE	LIFTING CAP. (LBS)	ANGLE	LIFTING CAP. (LBS)	LOAD RADIUS (FT)
LENGTH	39.3 FT		53 FT		66 FT		79 FT		92 FT		105 FT		118 FT		131 FT		
6	74°	130000															6
8	70°	120000															8
10	67°	104870	74°	80000	77°	73200											10
12	64°	95630	71°	80000	76°	68990	78°	54510									12
15	59°	84050	68°	74250	73°	62490	76°	49640	79°	38040							15
20	50°	59910	62°	61640	68°	53070	72°	43090	75°	33510	78°	28990					20
25	40°	36890	55°	38340	63°	39120	69°	37560	72°	29440	75°	25810	77°	22810			25
30	26°	25320	49°	26700	58°	27400	65°	27850	69°	26050	72°	23390	75°	20770	77°	18180	30
35			41°	19700	53°	20360	61°	20780	66°	21070	69°	21000	73°	18830	75°	16770	35
40			31°	15010	47°	15660	56°	16070	62°	16340	66°	16550	70°	16700	73°	15360	40
45			18°	11610	41°	12300	52°	12700	58°	12960	63°	13160	67°	13310	70°	13420	45
50					35°	9770	47°	10160	55°	10430	60°	10620	65°	10760	68°	10870	50
55					28°	7780	41°	8190	51°	8450	57°	8640	62°	8770	66°	8880	55
60					18°	6110	35°	6600	46°	6870	54°	7050	59°	7190	63°	7290	60
65							28°	5300	42°	5570	50°	5750	56°	5890	61°	5990	65
70							18°	4190	36°	4480	46°	4670	53°	4800	58°	4910	70
75									30°	3560	42°	3750	50°	3890	55°	3990	75
80									23°	2760	38°	2960	46°	3100	52°	3200	80
85									11°	2040	33°	2270	43°	2410	49°	2510	85
90											27°	1660	39°	1810	46°	1910	90
95											19°	1120	34°	1280	43°	1380	95
100													29°	800	39°	910	100
105																	105
110																	110
115																	115
120																	120
125																	125
130																	130
DEDUCTIONS FOR MAIN BOOM CAPACITIES	0°	21450	0°	10450	0°	6050	0°	3550	0°	1850	0°	650	0°	0	0°	0	
		1570		1140		920		770		660		580		520		460	STOWED
		3510		3240		3100		3010		2940		2890		2850		2820	RET
		3910		3530		3340		3200		3110		3040		2980		2940	EXT
	2620		2420		2320		2250		2200		2170		2140		2120	FIXED	

CODE 24

MAIN BOOM

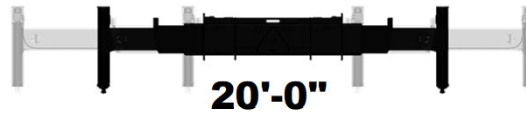
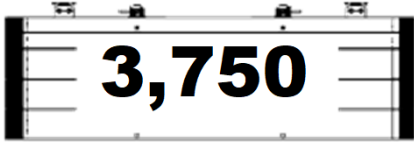

LOAD RADIUS (FT)	ANGLE	LIFTING CAP. (LBS)	ANGLE	LIFTING CAP. (LBS)	ANGLE	LIFTING CAP. (LBS)	ANGLE	LIFTING CAP. (LBS)	ANGLE	LIFTING CAP. (LBS)	ANGLE	LIFTING CAP. (LBS)	ANGLE	LIFTING CAP. (LBS)	ANGLE	LIFTING CAP. (LBS)	LOAD RADIUS (FT)
LENGTH	39.3 FT		53 FT		66 FT		79 FT		92 FT		105 FT		118 FT		131 FT		
6	74°	130000															6
8	70°	120000															8
10	67°	104870	74°	80000	77°	73200											10
12	64°	95630	71°	80000	76°	68990	78°	54510									12
15	59°	84050	68°	74250	73°	62490	76°	49640	79°	38040							15
20	50°	57740	62°	59480	68°	53070	72°	43090	75°	33510	78°	28990					20
25	40°	35450	55°	36900	63°	37680	69°	37560	72°	29440	75°	25810	77°	22810			25
30	26°	24240	49°	25620	58°	26320	65°	26770	69°	26050	72°	23390	75°	20770	77°	18180	30
35			41°	18840	53°	19500	61°	19920	66°	20210	69°	20430	73°	18830	75°	16770	35
40			31°	14290	47°	14940	56°	15350	62°	15620	66°	15830	70°	15980	73°	15360	40
45			18°	10990	41°	11680	52°	12080	58°	12350	63°	12540	67°	12690	70°	12800	45
50					35°	9230	47°	9620	55°	9890	60°	10080	65°	10220	68°	10330	50
55					28°	7300	41°	7710	51°	7970	57°	8160	62°	8300	66°	8400	55
60					18°	5680	35°	6170	46°	6440	54°	6620	59°	6760	63°	6860	60
65							28°	4900	42°	5180	50°	5360	56°	5500	61°	5600	65
70							18°	3830	36°	4120	46°	4310	53°	4440	58°	4550	70
75									30°	3230	42°	3420	50°	3550	55°	3660	75
80									23°	2450	38°	2650	46°	2790	52°	2890	80
85									11°	1750	33°	1980	43°	2120	49°	2230	85
90											27°	1390	39°	1540	46°	1650	90
95											19°	860	34°	1020	43°	1130	95
100																	100
105																	105
110																	110
115																	115
120																	120
125																	125
130																	130
DEDUCTIONS FOR MAIN BOOM CAPACITIES	0°	20500	0°	9900	0°	5600	0°	3200	0°	1600	0°	400	0°	0	0°	0	
		1570		1140		920		770		660		580		520		460	STOWED
		3510		3240		3100		3010		2940		2890		2850		2820	RET
		3910		3530		3340		3200		3110		3040		2980		2940	EXT
	2620		2420		2320		2250		2200		2170		2140		2120	FIXED	

CODE 25

MAIN BOOM

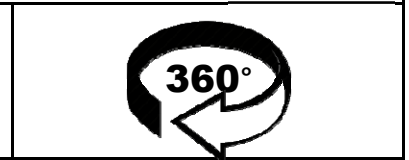
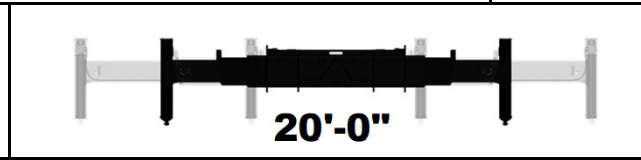
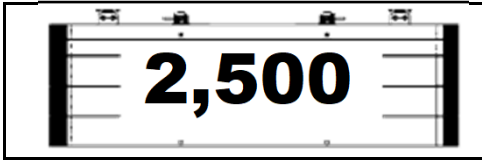

LOAD RADIUS (FT)	ANGLE	LIFTING CAP. (LBS)	ANGLE	LIFTING CAP. (LBS)	ANGLE	LIFTING CAP. (LBS)	ANGLE	LIFTING CAP. (LBS)	ANGLE	LIFTING CAP. (LBS)	ANGLE	LIFTING CAP. (LBS)	ANGLE	LIFTING CAP. (LBS)	ANGLE	LIFTING CAP. (LBS)	LOAD RADIUS (FT)
LENGTH	39.3 FT		53 FT		66 FT		79 FT		92 FT		105 FT		118 FT		131 FT		
6	74°	130000															6
8	70°	120000															8
10	67°	104870	74°	80000	77°	73200											10
12	64°	95630	71°	80000	76°	68990	78°	54510									12
15	59°	84050	68°	74250	73°	62490	76°	49640	79°	38040							15
20	50°	55580	62°	57310	68°	53070	72°	43090	75°	33510	78°	28990					20
25	40°	34010	55°	35460	63°	36240	69°	36750	72°	29440	75°	25810	77°	22810			25
30	26°	23160	49°	24540	58°	25240	65°	25690	69°	26010	72°	23390	75°	20770	77°	18180	30
35			41°	17970	53°	18630	61°	19050	66°	19340	69°	19560	73°	18830	75°	16770	35
40			31°	13570	47°	14220	56°	14630	62°	14900	66°	15110	70°	15260	73°	15360	40
45			18°	10380	41°	11070	52°	11460	58°	11730	63°	11920	67°	12070	70°	12190	45
50					35°	8690	47°	9090	55°	9350	60°	9540	65°	9680	68°	9790	50
55					28°	6820	41°	7230	51°	7490	57°	7680	62°	7820	66°	7920	55
60					18°	5250	35°	5740	46°	6000	54°	6190	59°	6320	63°	6430	60
65							28°	4510	42°	4780	50°	4970	56°	5100	61°	5210	65
70							18°	3470	36°	3760	46°	3950	53°	4090	58°	4190	70
75									30°	2890	42°	3090	50°	3220	55°	3320	75
80									23°	2140	38°	2340	46°	2480	52°	2580	80
85									11°	1460	33°	1700	43°	1840	49°	1940	85
90											27°	1120	39°	1270	46°	1380	90
95													34°	770	43°	880	95
100																	100
105																	105
110																	110
115																	115
120																	120
125																	125
130																	130
DEDUCTIONS FOR MAIN BOOM CAPACITIES	0°	19500	0°	9300	0°	5150	0°	2850	0°	1300	0°	0	0°	0	0°	0	
		1570		1140		920		770		660		580		520		460	STOWED
		3510		3240		3100		3010		2940		2890		2850		2820	RET
		3910		3530		3340		3200		3110		3040		2980		2940	EXT
	2620		2420		2320		2250		2200		2170		2140		2120	FIXED	

CODE 26

MAIN BOOM

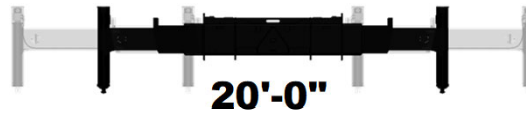

LOAD RADIUS (FT)	ANGLE	LIFTING CAP. (LBS)	ANGLE	LIFTING CAP. (LBS)	ANGLE	LIFTING CAP. (LBS)	ANGLE	LIFTING CAP. (LBS)	ANGLE	LIFTING CAP. (LBS)	ANGLE	LIFTING CAP. (LBS)	ANGLE	LIFTING CAP. (LBS)	ANGLE	LIFTING CAP. (LBS)	LOAD RADIUS (FT)
LENGTH	39.3 FT		53 FT		66 FT		79 FT		92 FT		105 FT		118 FT		131 FT		
6	74°	130000															6
8	70°	120000															8
10	67°	104870	74°	80000	77°	73200											10
12	64°	95630	71°	80000	76°	68990	78°	54510									12
15	59°	83550	68°	74250	73°	62490	76°	49640	79°	38040							15
20	50°	53410	62°	55150	68°	53070	72°	43090	75°	33510	78°	28990					20
25	40°	32570	55°	34020	63°	34800	69°	35310	72°	29440	75°	25810	77°	22810			25
30	26°	22080	49°	23460	58°	24150	65°	24610	69°	24930	72°	23390	75°	20770	77°	18180	30
35			41°	17110	53°	17770	61°	18190	66°	18480	69°	18700	73°	18830	75°	16770	35
40			31°	12850	47°	13500	56°	13910	62°	14180	66°	14390	70°	14540	73°	14660	40
45			18°	9760	41°	10450	52°	10850	58°	11110	63°	11310	67°	11450	70°	11570	45
50					35°	8150	47°	8550	55°	8810	60°	9000	65°	9140	68°	9250	50
55					28°	6340	41°	6750	51°	7010	57°	7200	62°	7340	66°	7440	55
60					18°	4820	35°	5310	46°	5570	54°	5760	59°	5890	63°	6000	60
65							28°	4120	42°	4390	50°	4580	56°	4710	61°	4810	65
70							18°	3110	36°	3400	46°	3590	53°	3730	58°	3830	70
75									30°	2560	42°	2750	50°	2890	55°	2990	75
80									23°	1830	38°	2030	46°	2170	52°	2270	80
85									11°	1170	33°	1410	43°	1550	49°	1650	85
90											27°	850	39°	1000	46°	1110	90
95																	95
100																	100
105																	105
110																	110
115																	115
120																	120
125																	125
130																	130
DEDUCTIONS FOR MAIN BOOM CAPACITIES	0°	18550	0°	8700	0°	4750	0°	2550	0°	1000	0°	0	0°	0	0°	0	
		1570		1140		920		770		660		580		520		460	STOWED
		3510		3240		3100		3010		2940		2890		2850		2820	RET
		3910		3530		3340		3200		3110		3040		2980		2940	EXT
	2620		2420		2320		2250		2200		2170		2140		2120	FIXED	

CODE 27

MAIN BOOM

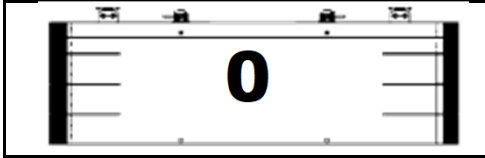

LOAD RADIUS (FT)	ANGLE	LIFTING CAP. (LBS)	ANGLE	LIFTING CAP. (LBS)	ANGLE	LIFTING CAP. (LBS)	ANGLE	LIFTING CAP. (LBS)	ANGLE	LIFTING CAP. (LBS)	ANGLE	LIFTING CAP. (LBS)	ANGLE	LIFTING CAP. (LBS)	ANGLE	LIFTING CAP. (LBS)	LOAD RADIUS (FT)
LENGTH	39.3 FT		53 FT		66 FT		79 FT		92 FT		105 FT		118 FT		131 FT		
6	74°	130000															6
8	70°	120000															8
10	67°	104870	74°	80000	77°	73200											10
12	64°	95630	71°	80000	76°	68990	78°	54510									12
15	59°	82700	68°	74250	73°	62490	76°	49640	79°	38040							15
20	50°	51250	62°	52980	68°	53070	72°	43090	75°	33510	78°	28990					20
25	40°	31120	55°	32580	63°	33350	69°	33870	72°	29440	75°	25810	77°	22810			25
30	26°	21000	49°	22380	58°	23070	65°	23530	69°	23850	72°	23390	75°	20770	77°	18180	30
35			41°	16240	53°	16900	61°	17320	66°	17620	69°	17830	73°	18000	75°	16770	35
40			31°	12130	47°	12780	56°	13190	62°	13460	66°	13670	70°	13820	73°	13940	40
45			18°	9140	41°	9830	52°	10230	58°	10500	63°	10690	67°	10840	70°	10950	45
50					35°	7610	47°	8010	55°	8270	60°	8460	65°	8600	68°	8710	50
55					28°	5860	41°	6270	51°	6530	57°	6720	62°	6860	66°	6960	55
60					18°	4390	35°	4880	46°	5140	54°	5320	59°	5460	63°	5570	60
65							28°	3730	42°	4000	50°	4180	56°	4320	61°	4420	65
70							18°	2750	36°	3040	46°	3230	53°	3370	58°	3470	70
75									30°	2230	42°	2420	50°	2560	55°	2660	75
80									23°	1520	38°	1730	46°	1860	52°	1970	80
85									11°	890	33°	1120	43°	1260	49°	1360	85
90															46°	840	90
95																	95
100																	100
105																	105
110																	110
115																	115
120																	120
125																	125
130																	130
DEDUCTIONS FOR MAIN BOOM CAPACITIES	0°	17600	0°	8150	0°	4300	0°	2200	0°	750	0°	0	0°	0	0°	0	
		1570		1140		920		770		660		580		520		460	STOWED
		3510		3240		3100		3010		2940		2890		2850		2820	RET
		3910		3530		3340		3200		3110		3040		2980		2940	EXT
	2620		2420		2320		2250		2200		2170		2140		2120	FIXED	

CODE 28

MAIN BOOM

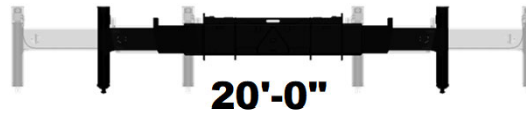

LOAD RADIUS (FT)	ANGLE	LIFTING CAP. (LBS)	ANGLE	LIFTING CAP. (LBS)	ANGLE	LIFTING CAP. (LBS)	ANGLE	LIFTING CAP. (LBS)	ANGLE	LIFTING CAP. (LBS)	ANGLE	LIFTING CAP. (LBS)	ANGLE	LIFTING CAP. (LBS)	ANGLE	LIFTING CAP. (LBS)	LOAD RADIUS (FT)
LENGTH	39.3 FT		53 FT		66 FT		79 FT		92 FT		105 FT		118 FT		131 FT		
6	74°	130000															6
8	70°	120000															8
10	67°	104870	74°	80000	77°	73200											10
12	64°	95630	71°	80000	76°	68990	78°	54510									12
15	59°	84050	68°	74250	73°	62490	76°	49640	79°	38040							15
20	50°	65540	62°	62410	68°	53070	72°	43090	75°	33510	78°	28990					20
25	40°	50810	55°	51800	63°	46050	69°	37560	72°	29440	75°	25810	77°	22810			25
30	26°	40810	49°	41860	58°	40230	65°	33320	69°	26050	72°	23390	75°	20770	77°	18180	30
35			41°	34620	53°	35220	61°	29630	66°	23500	69°	21000	73°	18830	75°	16770	35
40			31°	27450	47°	28100	56°	26450	62°	21000	66°	18910	70°	17110	73°	15360	40
45			18°	22270	41°	22970	52°	23360	58°	18920	63°	17130	67°	15520	70°	14070	45
50					35°	19100	47°	19500	55°	17110	60°	15540	65°	14150	68°	12900	50
55					28°	16070	41°	16490	51°	15570	57°	14150	62°	12930	66°	12100	55
60					18°	13580	35°	14070	46°	14210	54°	12920	59°	12100	63°	11110	60
65							28°	12090	42°	12360	50°	12100	56°	11100	61°	10190	65
70							18°	10410	36°	10710	46°	10890	53°	10190	58°	9370	70
75									30°	9300	42°	9500	50°	9360	55°	8620	75
80									23°	8090	38°	8300	46°	8430	52°	7940	80
85									11°	7020	33°	7250	43°	7390	49°	7310	85
90											27°	6330	39°	6480	46°	6580	90
95											19°	5510	34°	5670	43°	5780	95
100													29°	4950	39°	5060	100
105													23°	4300	36°	4420	105
110													14°	3700	31°	3840	110
115															26°	3310	115
120															19°	2820	120
125															6°	2360	125
130																	130
DEDUCTIONS FOR MAIN BOOM CAPACITIES	0°	30700	0°	18700	0°	13350	0°	8650	0°	6600	0°	4350	0°	3250	0°	600	
		1570		1140		920		770		660		580		520		460	STOWED
		3510		3240		3100		3010		2940		2890		2850		2820	RET
		3910		3530		3340		3200		3110		3040		2980		2940	EXT
	2620		2420		2320		2250		2200		2170		2140		2120	FIXED	

CODE 29

MAIN BOOM

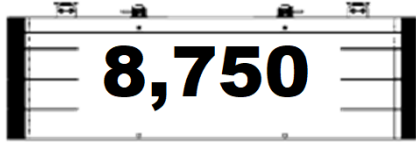

LOAD RADIUS (FT)	ANGLE	LIFTING CAP. (LBS)	ANGLE	LIFTING CAP. (LBS)	ANGLE	LIFTING CAP. (LBS)	ANGLE	LIFTING CAP. (LBS)	ANGLE	LIFTING CAP. (LBS)	ANGLE	LIFTING CAP. (LBS)	ANGLE	LIFTING CAP. (LBS)	ANGLE	LIFTING CAP. (LBS)	LOAD RADIUS (FT)
LENGTH	39.3 FT		53 FT		66 FT		79 FT		92 FT		105 FT		118 FT		131 FT		
6	74°	130000															6
8	70°	120000															8
10	67°	104870	74°	80000	77°	73200											10
12	64°	95630	71°	80000	76°	68990	78°	54510									12
15	59°	84050	68°	74250	73°	62490	76°	49640	79°	38040							15
20	50°	64890	62°	62410	68°	53070	72°	43090	75°	33510	78°	28990					20
25	40°	50280	55°	51280	63°	46050	69°	37560	72°	29440	75°	25810	77°	22810			25
30	26°	40370	49°	41420	58°	40230	65°	33320	69°	26050	72°	23390	75°	20770	77°	18180	30
35			41°	33760	53°	34420	61°	29630	66°	23500	69°	21000	73°	18830	75°	16770	35
40			31°	26730	47°	27380	56°	26450	62°	21000	66°	18910	70°	17110	73°	15360	40
45			18°	21660	41°	22350	52°	22740	58°	18920	63°	17130	67°	15520	70°	14070	45
50					35°	18560	47°	18960	55°	17110	60°	15540	65°	14150	68°	12900	50
55					28°	15600	41°	16010	51°	15570	57°	14150	62°	12930	66°	12100	55
60					18°	13150	35°	13640	46°	13900	54°	12920	59°	12100	63°	11110	60
65							28°	11690	42°	11970	50°	12100	56°	11100	61°	10190	65
70							18°	10050	36°	10350	46°	10530	53°	10190	58°	9370	70
75									30°	8970	42°	9160	50°	9300	55°	8620	75
80									23°	7780	38°	7990	46°	8130	52°	7940	80
85									11°	6730	33°	6960	43°	7100	49°	7210	85
90											27°	6060	39°	6210	46°	6310	90
95											19°	5260	34°	5420	43°	5530	95
100													29°	4710	39°	4820	100
105													23°	4070	36°	4190	105
110													14°	3490	31°	3620	110
115															26°	3100	115
120															19°	2630	120
125															6°	2170	125
130																	130
DEDUCTIONS FOR MAIN BOOM CAPACITIES	0°	30500	0°	18350	0°	12950	0°	8500	0°	6350	0°	4350	0°	3150	0°	600	
		1570		1140		920		770		660		580		520		460	STOWED
		3510		3240		3100		3010		2940		2890		2850		2820	RET
		3910		3530		3340		3200		3110		3040		2980		2940	EXT
		2620		2420		2320		2250		2200		2170		2140		2120	FIXED

CODE 30

MAIN BOOM

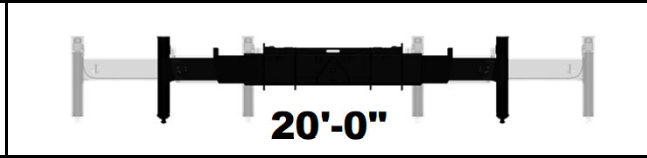
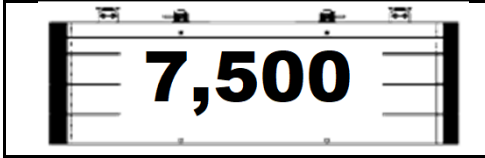

LOAD RADIUS (FT)	ANGLE	LIFTING CAP. (LBS)	ANGLE	LIFTING CAP. (LBS)	ANGLE	LIFTING CAP. (LBS)	ANGLE	LIFTING CAP. (LBS)	ANGLE	LIFTING CAP. (LBS)	ANGLE	LIFTING CAP. (LBS)	ANGLE	LIFTING CAP. (LBS)	ANGLE	LIFTING CAP. (LBS)	LOAD RADIUS (FT)
LENGTH	39.3 FT		53 FT		66 FT		79 FT		92 FT		105 FT		118 FT		131 FT		
6	74°	130000															6
8	70°	120000															8
10	67°	104870	74°	80000	77°	73200											10
12	64°	95630	71°	80000	76°	68990	78°	54510									12
15	59°	84050	68°	74250	73°	62490	76°	49640	79°	38040							15
20	50°	64240	62°	62410	68°	53070	72°	43090	75°	33510	78°	28990					20
25	40°	49760	55°	50750	63°	46050	69°	37560	72°	29440	75°	25810	77°	22810			25
30	26°	39930	49°	40980	58°	40230	65°	33320	69°	26050	72°	23390	75°	20770	77°	18180	30
35			41°	32900	53°	33560	61°	29630	66°	23500	69°	21000	73°	18830	75°	16770	35
40			31°	26010	47°	26670	56°	26450	62°	21000	66°	18910	70°	17110	73°	15360	40
45			18°	21040	41°	21730	52°	22130	58°	18920	63°	17130	67°	15520	70°	14070	45
50					35°	18020	47°	18420	55°	17110	60°	15540	65°	14150	68°	12900	50
55					28°	15120	41°	15530	51°	15570	57°	14150	62°	12930	66°	12100	55
60					18°	12720	35°	13210	46°	13470	54°	12920	59°	12100	63°	11110	60
65							28°	11300	42°	11580	50°	11760	56°	11100	61°	10190	65
70							18°	9690	36°	9990	46°	10180	53°	10190	58°	9370	70
75									30°	8640	42°	8830	50°	8970	55°	8620	75
80									23°	7480	38°	7680	46°	7820	52°	7920	80
85									11°	6440	33°	6680	43°	6820	49°	6920	85
90											27°	5790	39°	5940	46°	6050	90
95											19°	5000	34°	5170	43°	5270	95
100													29°	4470	39°	4580	100
105													23°	3850	36°	3970	105
110													14°	3270	31°	3410	110
115															26°	2900	115
120															19°	2430	120
125															6°	1980	125
130																	130
DEDUCTIONS FOR MAIN BOOM CAPACITIES	0°	30300	0°	18050	0°	12550	0°	8400	0°	6150	0°	4300	0°	3000	0°	600	
		1570		1140		920		770		660		580		520		460	STOWED
		3510		3240		3100		3010		2940		2890		2850		2820	RET
		3910		3530		3340		3200		3110		3040		2980		2940	EXT
	2620		2420		2320		2250		2200		2170		2140		2120	FIXED	

CODE 31

MAIN BOOM

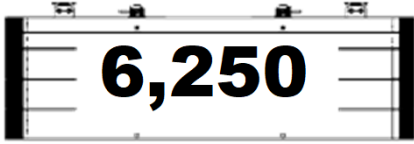

LOAD RADIUS (FT)	ANGLE	LIFTING CAP. (LBS)	ANGLE	LIFTING CAP. (LBS)	ANGLE	LIFTING CAP. (LBS)	ANGLE	LIFTING CAP. (LBS)	ANGLE	LIFTING CAP. (LBS)	ANGLE	LIFTING CAP. (LBS)	ANGLE	LIFTING CAP. (LBS)	ANGLE	LIFTING CAP. (LBS)	LOAD RADIUS (FT)
LENGTH	39.3 FT		53 FT		66 FT		79 FT		92 FT		105 FT		118 FT		131 FT		
6	74°	130000															6
8	70°	120000															8
10	67°	104870	74°	80000	77°	73200											10
12	64°	95630	71°	80000	76°	68990	78°	54510									12
15	59°	84050	68°	74250	73°	62490	76°	49640	79°	38040							15
20	50°	63580	62°	62410	68°	53070	72°	43090	75°	33510	78°	28990					20
25	40°	49240	55°	50230	63°	46050	69°	37560	72°	29440	75°	25810	77°	22810			25
30	26°	39490	49°	40540	58°	40230	65°	33320	69°	26050	72°	23390	75°	20770	77°	18180	30
35			41°	32030	53°	32690	61°	29630	66°	23500	69°	21000	73°	18830	75°	16770	35
40			31°	25290	47°	25950	56°	26350	62°	21000	66°	18910	70°	17110	73°	15360	40
45			18°	20430	41°	21120	52°	21510	58°	18920	63°	17130	67°	15520	70°	14070	45
50					35°	17480	47°	17880	55°	17110	60°	15540	65°	14150	68°	12900	50
55					28°	14640	41°	15050	51°	15310	57°	14150	62°	12930	66°	12100	55
60					18°	12290	35°	12780	46°	13040	54°	12920	59°	12100	63°	11110	60
65							28°	10910	42°	11180	50°	11370	56°	11100	61°	10190	65
70							18°	9340	36°	9630	46°	9820	53°	9950	58°	9370	70
75									30°	8310	42°	8500	50°	8640	55°	8620	75
80									23°	7170	38°	7370	46°	7510	52°	7610	80
85									11°	6160	33°	6390	43°	6530	49°	6630	85
90											27°	5520	39°	5670	46°	5780	90
95											19°	4750	34°	4910	43°	5020	95
100													29°	4230	39°	4340	100
105													23°	3620	36°	3740	105
110													14°	3060	31°	3190	110
115															26°	2690	115
120															19°	2240	120
125															6°	1790	125
130																	130
DEDUCTIONS FOR MAIN BOOM CAPACITIES	0°	30100	0°	17700	0°	12150	0°	8300	0°	5950	0°	4150	0°	2800	0°	600	
		1570		1140		920		770		660		580		520		460	STOWED
		3510		3240		3100		3010		2940		2890		2850		2820	RET
		3910		3530		3340		3200		3110		3040		2980		2940	EXT
	2620		2420		2320		2250		2200		2170		2140		2120	FIXED	

CODE 32

MAIN BOOM

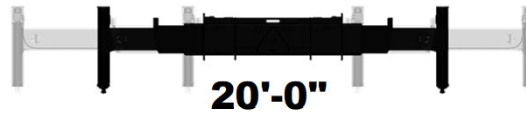

LOAD RADIUS (FT)	ANGLE	LIFTING CAP. (LBS)	ANGLE	LIFTING CAP. (LBS)	ANGLE	LIFTING CAP. (LBS)	ANGLE	LIFTING CAP. (LBS)	ANGLE	LIFTING CAP. (LBS)	ANGLE	LIFTING CAP. (LBS)	ANGLE	LIFTING CAP. (LBS)	ANGLE	LIFTING CAP. (LBS)	LOAD RADIUS (FT)
LENGTH	39.3 FT		53 FT		66 FT		79 FT		92 FT		105 FT		118 FT		131 FT		
6	74°	130000															6
8	70°	120000															8
10	67°	104870	74°	80000	77°	73200											10
12	64°	95630	71°	80000	76°	68990	78°	54510									12
15	59°	84050	68°	74250	73°	62490	76°	49640	79°	38040							15
20	50°	62930	62°	62410	68°	53070	72°	43090	75°	33510	78°	28990					20
25	40°	48710	55°	49700	63°	46050	69°	37560	72°	29440	75°	25810	77°	22810			25
30	26°	39050	49°	40100	58°	40230	65°	33320	69°	26050	72°	23390	75°	20770	77°	18180	30
35			41°	31170	53°	31830	61°	29630	66°	23500	69°	21000	73°	18830	75°	16770	35
40			31°	24580	47°	25230	56°	25630	62°	21000	66°	18910	70°	17110	73°	15360	40
45			18°	19810	41°	20500	52°	20900	58°	18920	63°	17130	67°	15520	70°	14070	45
50					35°	16950	47°	17340	55°	17110	60°	15540	65°	14150	68°	12900	50
55					28°	14160	41°	14570	51°	14830	57°	14150	62°	12930	66°	12100	55
60					18°	11860	35°	12350	46°	12610	54°	12800	59°	12100	63°	11110	60
65							28°	10520	42°	10790	50°	10980	56°	11100	61°	10190	65
70							18°	8980	36°	9270	46°	9460	53°	9590	58°	9370	70
75									30°	7980	42°	8170	50°	8310	55°	8410	75
80									23°	6860	38°	7060	46°	7200	52°	7300	80
85									11°	5870	33°	6100	43°	6240	49°	6350	85
90											27°	5260	39°	5400	46°	5510	90
95											19°	4500	34°	4660	43°	4770	95
100													29°	3990	39°	4100	100
105													23°	3390	36°	3510	105
110													14°	2840	31°	2980	110
115															26°	2490	115
120															19°	2040	120
125															6°	1610	125
130																	130
DEDUCTIONS FOR MAIN BOOM CAPACITIES	0°	29900	0°	17350	0°	11750	0°	8100	0°	5650	0°	3900	0°	2600	0°	600	
		1570		1140		920		770		660		580		520		460	STOWED
		3510		3240		3100		3010		2940		2890		2850		2820	RET
		3910		3530		3340		3200		3110		3040		2980		2940	EXT
	2620		2420		2320		2250		2200		2170		2140		2120	FIXED	

CODE 33

MAIN BOOM

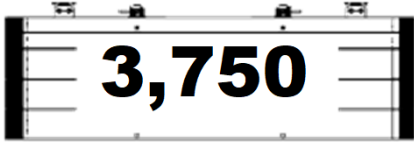

LOAD RADIUS (FT)	ANGLE	LIFTING CAP. (LBS)	ANGLE	LIFTING CAP. (LBS)	ANGLE	LIFTING CAP. (LBS)	ANGLE	LIFTING CAP. (LBS)	ANGLE	LIFTING CAP. (LBS)	ANGLE	LIFTING CAP. (LBS)	ANGLE	LIFTING CAP. (LBS)	ANGLE	LIFTING CAP. (LBS)	LOAD RADIUS (FT)
LENGTH	39.3 FT		53 FT		66 FT		79 FT		92 FT		105 FT		118 FT		131 FT		
6	74°	130000															6
8	70°	120000															8
10	67°	104870	74°	80000	77°	73200											10
12	64°	95630	71°	80000	76°	68990	78°	54510									12
15	59°	84050	68°	74250	73°	62490	76°	49640	79°	38040							15
20	50°	62280	62°	62410	68°	53070	72°	43090	75°	33510	78°	28990					20
25	40°	48190	55°	49180	63°	46050	69°	37560	72°	29440	75°	25810	77°	22810			25
30	26°	38580	49°	39660	58°	40180	65°	33320	69°	26050	72°	23390	75°	20770	77°	18180	30
35			41°	30310	53°	30970	61°	29630	66°	23500	69°	21000	73°	18830	75°	16770	35
40			31°	23860	47°	24510	56°	24910	62°	21000	66°	18910	70°	17110	73°	15360	40
45			18°	19200	41°	19890	52°	20280	58°	18920	63°	17130	67°	15520	70°	14070	45
50					35°	16410	47°	16800	55°	17070	60°	15540	65°	14150	68°	12900	50
55					28°	13680	41°	14090	51°	14350	57°	14150	62°	12930	66°	12100	55
60					18°	11430	35°	11920	46°	12180	54°	12370	59°	12100	63°	11110	60
65							28°	10130	42°	10400	50°	10580	56°	10720	61°	10190	65
70							18°	8620	36°	8910	46°	9100	53°	9230	58°	9340	70
75									30°	7650	42°	7840	50°	7970	55°	8080	75
80									23°	6550	38°	6760	46°	6890	52°	7000	80
85									11°	5580	33°	5820	43°	5960	49°	6060	85
90											27°	4990	39°	5130	46°	5240	90
95											19°	4240	34°	4410	43°	4510	95
100													29°	3750	39°	3870	100
105													23°	3170	36°	3290	105
110													14°	2630	31°	2760	110
115															26°	2280	115
120															19°	1840	120
125															6°	1420	125
130																	130
DEDUCTIONS FOR MAIN BOOM CAPACITIES	0°	29700	0°	17000	0°	11300	0°	7750	0°	5350	0°	3650	0°	2400	0°	600	
		1570		1140		920		770		660		580		520		460	STOWED
		3510		3240		3100		3010		2940		2890		2850		2820	RET
		3910		3530		3340		3200		3110		3040		2980		2940	EXT
	2620		2420		2320		2250		2200		2170		2140		2120	FIXED	

CODE 34

MAIN BOOM

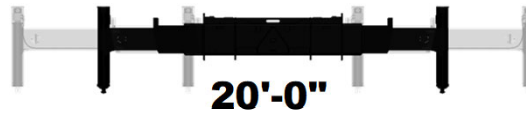
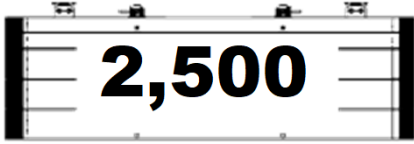

LOAD RADIUS (FT)	ANGLE	LIFTING CAP. (LBS)	ANGLE	LIFTING CAP. (LBS)	ANGLE	LIFTING CAP. (LBS)	ANGLE	LIFTING CAP. (LBS)	ANGLE	LIFTING CAP. (LBS)	ANGLE	LIFTING CAP. (LBS)	ANGLE	LIFTING CAP. (LBS)	ANGLE	LIFTING CAP. (LBS)	LOAD RADIUS (FT)
LENGTH	39.3 FT		53 FT		66 FT		79 FT		92 FT		105 FT		118 FT		131 FT		
6	74°	130000															6
8	70°	120000															8
10	67°	104870	74°	80000	77°	73200											10
12	64°	95630	71°	80000	76°	68990	78°	54510									12
15	59°	84050	68°	74250	73°	62490	76°	49640	79°	38040							15
20	50°	61630	62°	62410	68°	53070	72°	43090	75°	33510	78°	28990					20
25	40°	47660	55°	48650	63°	46050	69°	37560	72°	29440	75°	25810	77°	22810			25
30	26°	37500	49°	38880	58°	39570	65°	33320	69°	26050	72°	23390	75°	20770	77°	18180	30
35			41°	29450	53°	30110	61°	29630	66°	23500	69°	21000	73°	18830	75°	16770	35
40			31°	23140	47°	23790	56°	24200	62°	21000	66°	18910	70°	17110	73°	15360	40
45			18°	18580	41°	19270	52°	19670	58°	18920	63°	17130	67°	15520	70°	14070	45
50					35°	15870	47°	16270	55°	16530	60°	15540	65°	14150	68°	12900	50
55					28°	13200	41°	13620	51°	13880	57°	14060	62°	12930	66°	12100	55
60					18°	11000	35°	11490	46°	11750	54°	11930	59°	12070	63°	11110	60
65							28°	9740	42°	10010	50°	10190	56°	10330	61°	10190	65
70							18°	8260	36°	8550	46°	8740	53°	8870	58°	8980	70
75									30°	7320	42°	7510	50°	7640	55°	7750	75
80									23°	6250	38°	6450	46°	6590	52°	6690	80
85									11°	5290	33°	5530	43°	5670	49°	5770	85
90											27°	4720	39°	4860	46°	4970	90
95											19°	3990	34°	4150	43°	4260	95
100													29°	3520	39°	3630	100
105													23°	2940	36°	3060	105
110													14°	2410	31°	2550	110
115															26°	2080	115
120															19°	1650	120
125															6°	1230	125
130																	130
DEDUCTIONS FOR MAIN BOOM CAPACITIES	0°	29200	0°	16700	0°	10900	0°	7400	0°	5100	0°	3400	0°	2200	0°	600	
		1570		1140		920		770		660		580		520		460	STOWED
		3510		3240		3100		3010		2940		2890		2850		2820	RET
		3910		3530		3340		3200		3110		3040		2980		2940	EXT
	2620		2420		2320		2250		2200		2170		2140		2120	FIXED	

CODE 35

MAIN BOOM



LOAD RADIUS (FT)	ANGLE	LIFTING CAP. (LBS)	ANGLE	LIFTING CAP. (LBS)	ANGLE	LIFTING CAP. (LBS)	ANGLE	LIFTING CAP. (LBS)	ANGLE	LIFTING CAP. (LBS)	ANGLE	LIFTING CAP. (LBS)	ANGLE	LIFTING CAP. (LBS)	ANGLE	LIFTING CAP. (LBS)	LOAD RADIUS (FT)
LENGTH	39.3 FT		53 FT		66 FT		79 FT		92 FT		105 FT		118 FT		131 FT		
6	74°	130000															6
8	70°	120000															8
10	67°	104870	74°	80000	77°	73200											10
12	64°	95630	71°	80000	76°	68990	78°	54510									12
15	59°	83550	68°	74250	73°	62490	76°	49640	79°	38040							15
20	50°	60980	62°	61950	68°	53070	72°	43090	75°	33510	78°	28990					20
25	40°	47140	55°	48130	63°	46050	69°	37560	72°	29440	75°	25810	77°	22810			25
30	26°	36420	49°	37800	58°	38500	65°	33320	69°	26050	72°	23390	75°	20770	77°	18180	30
35			41°	28590	53°	29250	61°	29630	66°	23500	69°	21000	73°	18830	75°	16770	35
40			31°	22420	47°	23080	56°	23480	62°	21000	66°	18910	70°	17110	73°	15360	40
45			18°	17970	41°	18660	52°	19050	58°	18920	63°	17130	67°	15520	70°	14070	45
50					35°	15330	47°	15730	55°	15990	60°	15540	65°	14150	68°	12900	50
55					28°	12720	41°	13140	51°	13400	57°	13580	62°	12930	66°	12100	55
60					18°	10570	35°	11060	46°	11320	54°	11500	59°	11640	63°	11110	60
65							28°	9350	42°	9620	50°	9800	56°	9940	61°	10040	65
70							18°	7900	36°	8190	46°	8380	53°	8520	58°	8620	70
75									30°	6980	42°	7180	50°	7310	55°	7410	75
80									23°	5940	38°	6140	46°	6280	52°	6380	80
85									11°	5010	33°	5240	43°	5380	49°	5480	85
90											27°	4450	39°	4600	46°	4700	90
95											19°	3740	34°	3900	43°	4010	95
100													29°	3280	39°	3390	100
105													23°	2710	36°	2830	105
110													14°	2200	31°	2330	110
115															26°	1870	115
120															19°	1450	120
125															6°	1050	125
130																	130
DEDUCTIONS FOR MAIN BOOM CAPACITIES	0°	28700	0°	16350	0°	10450	0°	7100	0°	4800	0°	3150	0°	1950	0°	600	
		1570		1140		920		770		660		580		520		460	STOWED
		3510		3240		3100		3010		2940		2890		2850		2820	RET
		3910		3530		3340		3200		3110		3040		2980		2940	EXT
	2620		2420		2320		2250		2200		2170		2140		2120	FIXED	

CODE 36

MAIN BOOM

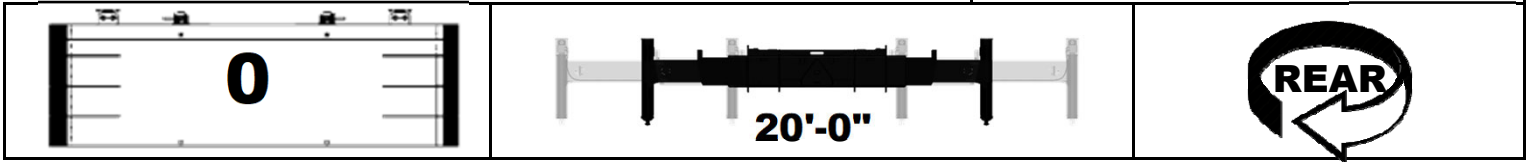

LOAD RADIUS (FT)	ANGLE	LIFTING CAP. (LBS)	ANGLE	LIFTING CAP. (LBS)	ANGLE	LIFTING CAP. (LBS)	ANGLE	LIFTING CAP. (LBS)	ANGLE	LIFTING CAP. (LBS)	ANGLE	LIFTING CAP. (LBS)	ANGLE	LIFTING CAP. (LBS)	ANGLE	LIFTING CAP. (LBS)	LOAD RADIUS (FT)
LENGTH	39.3 FT		53 FT		66 FT		79 FT		92 FT		105 FT		118 FT		131 FT		
6	74°	130000															6
8	70°	120000															8
10	67°	104870	74°	80000	77°	73200											10
12	64°	95630	71°	80000	76°	68990	78°	54510									12
15	59°	82700	68°	74250	73°	62490	76°	49640	79°	38040							15
20	50°	60330	62°	61300	68°	53070	72°	43090	75°	33510	78°	28990					20
25	40°	46610	55°	47600	63°	46050	69°	37560	72°	29440	75°	25810	77°	22810			25
30	26°	35350	49°	36720	58°	37420	65°	33320	69°	26050	72°	23390	75°	20770	77°	18180	30
35			41°	27730	53°	28390	61°	28810	66°	23500	69°	21000	73°	18830	75°	16770	35
40			31°	21700	47°	22360	56°	22760	62°	21000	66°	18910	70°	17110	73°	15360	40
45			18°	17350	41°	18040	52°	18440	58°	18700	63°	17130	67°	15520	70°	14070	45
50					35°	14790	47°	15190	55°	15450	60°	15540	65°	14150	68°	12900	50
55					28°	12250	41°	12660	51°	12920	57°	13100	62°	12930	66°	12100	55
60					18°	10140	35°	10630	46°	10890	54°	11070	59°	11210	63°	11110	60
65							28°	8950	42°	9230	50°	9410	56°	9550	61°	9650	65
70							18°	7540	36°	7840	46°	8020	53°	8160	58°	8260	70
75									30°	6650	42°	6850	50°	6980	55°	7080	75
80									23°	5630	38°	5830	46°	5970	52°	6070	80
85									11°	4720	33°	4950	43°	5090	49°	5200	85
90											27°	4180	39°	4330	46°	4430	90
95											19°	3480	34°	3650	43°	3750	95
100													29°	3040	39°	3150	100
105													23°	2490	36°	2610	105
110													14°	1980	31°	2110	110
115															26°	1670	115
120															19°	1260	120
125															6°	860	125
130																	130
DEDUCTIONS FOR MAIN BOOM CAPACITIES	0°	28250	0°	15900	0°	10050	0°	6750	0°	4500	0°	2900	0°	1750	0°	600	
		1570		1140		920		770		660		580		520		460	STOWED
		3510		3240		3100		3010		2940		2890		2850		2820	RET
		3910		3530		3340		3200		3110		3040		2980		2940	EXT
	2620		2420		2320		2250		2200		2170		2140		2120	FIXED	

CODE 37

MAIN BOOM



10,000

17'-6"

360°

LOAD RADIUS (FT)	ANGLE	LIFTING CAP. (LBS)	ANGLE	LIFTING CAP. (LBS)	ANGLE	LIFTING CAP. (LBS)	ANGLE	LIFTING CAP. (LBS)	ANGLE	LIFTING CAP. (LBS)	ANGLE	LIFTING CAP. (LBS)	ANGLE	LIFTING CAP. (LBS)	ANGLE	LIFTING CAP. (LBS)	LOAD RADIUS (FT)
LENGTH		39.3 FT	53 FT		66 FT		79 FT		92 FT		105 FT		118 FT		131 FT		
6	74°	130000															6
8	70°	120000															8
10	67°	104870	74°	80000	77°	73200											10
12	64°	95630	71°	80000	76°	68990	78°	54510									12
15	59°	84050	68°	74250	73°	62490	76°	49640	79°	38040							15
20	50°	52890	62°	54420	68°	53070	72°	43090	75°	33510	78°	28990					20
25	40°	33860	55°	35200	63°	35910	69°	36380	72°	29440	75°	25810	77°	22810			25
30	26°	23710	49°	25000	58°	25650	65°	26080	69°	26050	72°	23390	75°	20770	77°	18180	30
35			41°	18670	53°	19300	61°	19690	66°	19970	69°	20170	73°	18830	75°	16770	35
40			31°	14340	47°	14960	56°	15350	62°	15610	66°	15800	70°	15950	73°	15360	40
45			18°	11150	41°	11820	52°	12200	58°	12450	63°	12640	67°	12780	70°	12890	45
50					35°	9420	47°	9800	55°	10060	60°	10240	65°	10380	68°	10480	50
55					28°	7520	41°	7920	51°	8180	57°	8360	62°	8490	66°	8590	55
60					18°	5930	35°	6400	46°	6660	54°	6840	59°	6970	63°	7070	60
65							28°	5140	42°	5410	50°	5590	56°	5720	61°	5820	65
70							18°	4070	36°	4360	46°	4540	53°	4670	58°	4770	70
75									30°	3460	42°	3650	50°	3780	55°	3880	75
80									23°	2680	38°	2880	46°	3010	52°	3110	80
85									11°	1980	33°	2210	43°	2350	49°	2450	85
90											27°	1610	39°	1760	46°	1860	90
95											19°	1080	34°	1240	43°	1340	95
100													29°	770	39°	880	100
105																	105
110																	110
115																	115
120																	120
125																	125
130																	130
DEDUCTIONS FOR MAIN BOOM CAPACITIES	0°	20200	0°	10050	0°	5850	0°	3450	0°	1800	0°	650	0°	0	0°	0	
		1570		1140		920		770		660		580		520		460	STOWED
		3510		3240		3100		3010		2940		2890		2850		2820	RET
		3910		3530		3340		3200		3110		3040		2980		2940	EXT
	2620		2420		2320		2250		2200		2170		2140		2120	FIXED	

CODE 38

MAIN BOOM

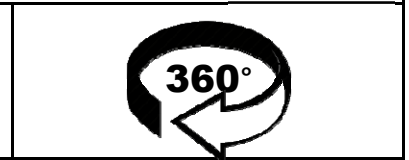
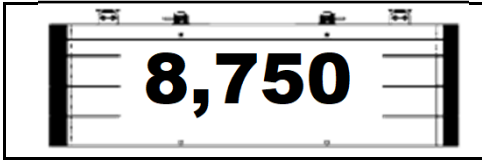

LOAD RADIUS (FT)	ANGLE	LIFTING CAP. (LBS)	ANGLE	LIFTING CAP. (LBS)	ANGLE	LIFTING CAP. (LBS)	ANGLE	LIFTING CAP. (LBS)	ANGLE	LIFTING CAP. (LBS)	ANGLE	LIFTING CAP. (LBS)	ANGLE	LIFTING CAP. (LBS)	ANGLE	LIFTING CAP. (LBS)	LOAD RADIUS (FT)
LENGTH	39.3 FT		53 FT		66 FT		79 FT		92 FT		105 FT		118 FT		131 FT		
6	74°	130000															6
8	70°	120000															8
10	67°	104870	74°	80000	77°	73200											10
12	64°	95630	71°	80000	76°	68990	78°	54510									12
15	59°	84050	68°	74250	73°	62490	76°	49640	79°	38040							15
20	50°	51080	62°	52620	68°	53070	72°	43090	75°	33510	78°	28990					20
25	40°	32610	55°	33950	63°	34660	69°	35130	72°	29440	75°	25810	77°	22810			25
30	26°	22750	49°	24040	58°	24700	65°	25120	69°	25420	72°	23390	75°	20770	77°	18180	30
35			41°	17900	53°	18520	61°	18920	66°	19200	69°	19400	73°	18830	75°	16770	35
40			31°	13690	47°	14320	56°	14700	62°	14960	66°	15160	70°	15300	73°	15360	40
45			18°	10590	41°	11260	52°	11640	58°	11890	63°	12080	67°	12220	70°	12330	45
50					35°	8930	47°	9310	55°	9570	60°	9750	65°	9880	68°	9990	50
55					28°	7090	41°	7490	51°	7740	57°	7920	62°	8050	66°	8150	55
60					18°	5530	35°	6010	46°	6270	54°	6440	59°	6570	63°	6680	60
65							28°	4780	42°	5050	50°	5230	56°	5360	61°	5460	65
70							18°	3740	36°	4030	46°	4210	53°	4340	58°	4440	70
75									30°	3160	42°	3340	50°	3480	55°	3570	75
80									23°	2400	38°	2600	46°	2730	52°	2830	80
85									11°	1710	33°	1940	43°	2080	49°	2180	85
90											27°	1360	39°	1510	46°	1610	90
95											19°	840	34°	1000	43°	1110	95
100																	100
105																	105
110																	110
115																	115
120																	120
125																	125
130																	130
DEDUCTIONS FOR MAIN BOOM CAPACITIES	0°	19350	0°	9550	0°	5450	0°	3150	0°	1550	0°	0	0°	0	0°	0	
		1570		1140		920		770		660		580		520		460	STOWED
		3510		3240		3100		3010		2940		2890		2850		2820	RET
		3910		3530		3340		3200		3110		3040		2980		2940	EXT
	2620		2420		2320		2250		2200		2170		2140		2120	FIXED	

CODE 39

MAIN BOOM

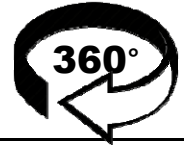

LOAD RADIUS (FT)	ANGLE	LIFTING CAP. (LBS)	ANGLE	LIFTING CAP. (LBS)	ANGLE	LIFTING CAP. (LBS)	ANGLE	LIFTING CAP. (LBS)	ANGLE	LIFTING CAP. (LBS)	ANGLE	LIFTING CAP. (LBS)	ANGLE	LIFTING CAP. (LBS)	ANGLE	LIFTING CAP. (LBS)	LOAD RADIUS (FT)
LENGTH	39.3 FT		53 FT		66 FT		79 FT		92 FT		105 FT		118 FT		131 FT		
6	74°	130000															6
8	70°	120000															8
10	67°	104870	74°	80000	77°	73200											10
12	64°	95630	71°	80000	76°	68990	78°	54510									12
15	59°	84050	68°	74250	73°	62490	76°	49640	79°	38040							15
20	50°	49280	62°	50820	68°	51660	72°	43090	75°	33510	78°	28990					20
25	40°	31360	55°	32700	63°	33410	69°	33880	72°	29440	75°	25810	77°	22810			25
30	26°	21800	49°	23090	58°	23740	65°	24170	69°	24460	72°	23390	75°	20770	77°	18180	30
35			41°	17120	53°	17750	61°	18150	66°	18420	69°	18630	73°	18790	75°	16770	35
40			31°	13040	47°	13670	56°	14050	62°	14310	66°	14510	70°	14650	73°	14770	40
45			18°	10030	41°	10700	52°	11080	58°	11330	63°	11520	67°	11660	70°	11770	45
50					35°	8440	47°	8820	55°	9070	60°	9260	65°	9390	68°	9500	50
55					28°	6650	41°	7050	51°	7300	57°	7480	62°	7610	66°	7720	55
60					18°	5140	35°	5610	46°	5870	54°	6050	59°	6180	63°	6280	60
65							28°	4420	42°	4690	50°	4870	56°	5000	61°	5100	65
70							18°	3410	36°	3700	46°	3880	53°	4010	58°	4110	70
75									30°	2850	42°	3040	50°	3170	55°	3270	75
80									23°	2110	38°	2310	46°	2450	52°	2540	80
85									11°	1450	33°	1680	43°	1810	49°	1920	85
90											27°	1120	39°	1260	46°	1360	90
95													34°	770	43°	870	95
100																	100
105																	105
110																	110
115																	115
120																	120
125																	125
130																	130
DEDUCTIONS FOR MAIN BOOM CAPACITIES	0°	18500	0°	9000	0°	5050	0°	2800	0°	1300	0°	0	0°	0	0°	0	
		1570		1140		920		770		660		580		520		460	STOWED
		3510		3240		3100		3010		2940		2890		2850		2820	RET
		3910		3530		3340		3200		3110		3040		2980		2940	EXT
	2620		2420		2320		2250		2200		2170		2140		2120	FIXED	

CODE 40

MAIN BOOM



6,250

17'-6"

360°

LOAD RADIUS (FT)	ANGLE	LIFTING CAP. (LBS)	ANGLE	LIFTING CAP. (LBS)	ANGLE	LIFTING CAP. (LBS)	ANGLE	LIFTING CAP. (LBS)	ANGLE	LIFTING CAP. (LBS)	ANGLE	LIFTING CAP. (LBS)	ANGLE	LIFTING CAP. (LBS)	ANGLE	LIFTING CAP. (LBS)	LOAD RADIUS (FT)	
LENGTH		39.3 FT		53 FT		66 FT		79 FT		92 FT		105 FT		118 FT		131 FT		
6	74°	130000																6
8	70°	120000																8
10	67°	104870	74°	80000	77°	73200												10
12	64°	95630	71°	80000	76°	68990	78°	54510										12
15	59°	84050	68°	74250	73°	62490	76°	49640	79°	38040								15
20	50°	47480	62°	49010	68°	49860	72°	43090	75°	33510	78°	28990						20
25	40°	30110	55°	31450	63°	32170	69°	32640	72°	29440	75°	25810	77°	22810				25
30	26°	20840	49°	22140	58°	22790	65°	23210	69°	23510	72°	23390	75°	20770	77°	18180		30
35			41°	16350	53°	16980	61°	17380	66°	17650	69°	17860	73°	18010	75°	16770		35
40			31°	12390	47°	13020	56°	13400	62°	13670	66°	13860	70°	14010	73°	14120		40
45			18°	9470	41°	10140	52°	10520	58°	10780	63°	10960	67°	11100	70°	11210		45
50					35°	7950	47°	8330	55°	8580	60°	8760	65°	8900	68°	9010		50
55					28°	6210	41°	6610	51°	6860	57°	7040	62°	7170	66°	7280		55
60					18°	4740	35°	5220	46°	5470	54°	5650	59°	5780	63°	5880		60
65							28°	4060	42°	4330	50°	4510	56°	4640	61°	4740		65
70							18°	3080	36°	3370	46°	3550	53°	3680	58°	3780		70
75									30°	2540	42°	2730	50°	2860	55°	2960		75
80									23°	1830	38°	2030	46°	2160	52°	2260		80
85									11°	1180	33°	1410	43°	1550	49°	1650		85
90											27°	870	39°	1010	46°	1110		90
95																		95
100																		100
105																		105
110																		110
115																		115
120																		120
125																		125
130																		130
DEDUCTIONS FOR MAIN BOOM CAPACITIES	0°	17600	0°	8500	0°	4650	0°	2500	0°	1050	0°	0	0°	0	0°	0		
		1570		1140		920		770		660		580		520		460		STOWED
		3510		3240		3100		3010		2940		2890		2850		2820		RET
		3910		3530		3340		3200		3110		3040		2980		2940		EXT
	2620		2420		2320		2250		2200		2170		2140		2120		FIXED	

CODE 41

MAIN BOOM

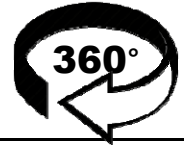
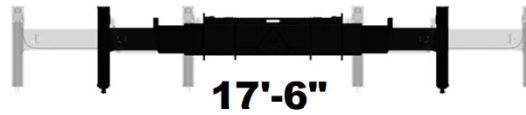

LOAD RADIUS (FT)	ANGLE	LIFTING CAP. (LBS)	ANGLE	LIFTING CAP. (LBS)	ANGLE	LIFTING CAP. (LBS)	ANGLE	LIFTING CAP. (LBS)	ANGLE	LIFTING CAP. (LBS)	ANGLE	LIFTING CAP. (LBS)	ANGLE	LIFTING CAP. (LBS)	ANGLE	LIFTING CAP. (LBS)	LOAD RADIUS (FT)
LENGTH	39.3 FT		53 FT		66 FT		79 FT		92 FT		105 FT		118 FT		131 FT		
6	74°	130000															6
8	70°	120000															8
10	67°	104870	74°	80000	77°	73200											10
12	64°	95630	71°	80000	76°	68990	78°	54510									12
15	59°	84050	68°	74250	73°	62490	76°	49640	79°	38040							15
20	50°	45680	62°	47210	68°	48060	72°	43090	75°	33510	78°	28990					20
25	40°	28870	55°	30200	63°	30920	69°	31390	72°	29440	75°	25810	77°	22810			25
30	26°	19890	49°	21180	58°	21840	65°	22260	69°	22560	72°	22780	75°	20770	77°	18180	30
35			41°	15580	53°	16210	61°	16600	66°	16880	69°	17080	73°	17240	75°	16770	35
40			31°	11740	47°	12370	56°	12750	62°	13020	66°	13210	70°	13360	73°	13470	40
45			18°	8910	41°	9580	52°	9960	58°	10220	63°	10400	67°	10540	70°	10650	45
50					35°	7460	47°	7840	55°	8090	60°	8270	65°	8410	68°	8520	50
55					28°	5770	41°	6170	51°	6420	57°	6600	62°	6740	66°	6840	55
60					18°	4350	35°	4820	46°	5080	54°	5260	59°	5390	63°	5490	60
65							28°	3700	42°	3970	50°	4150	56°	4280	61°	4380	65
70							18°	2750	36°	3040	46°	3220	53°	3350	58°	3450	70
75									30°	2240	42°	2430	50°	2560	55°	2660	75
80									23°	1540	38°	1740	46°	1880	52°	1980	80
85									11°	920	33°	1150	43°	1280	49°	1380	85
90													39°	760	46°	860	90
95																	95
100																	100
105																	105
110																	110
115																	115
120																	120
125																	125
130																	130
DEDUCTIONS FOR MAIN BOOM CAPACITIES	0°	16750	0°	7950	0°	4300	0°	2200	0°	750	0°	0	0°	0	0°	0	
		1570		1140		920		770		660		580		520		460	STOWED
		3510		3240		3100		3010		2940		2890		2850		2820	RET
		3910		3530		3340		3200		3110		3040		2980		2940	EXT
	2620		2420		2320		2250		2200		2170		2140		2120	FIXED	

CODE 42

MAIN BOOM

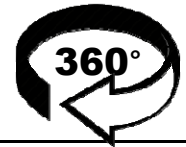
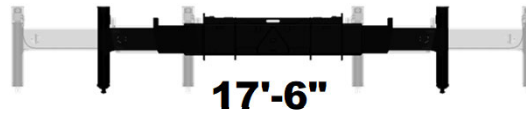
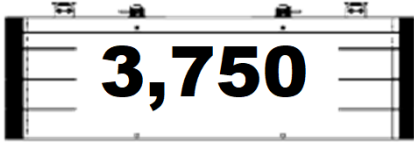

LOAD RADIUS (FT)	ANGLE	LIFTING CAP. (LBS)	ANGLE	LIFTING CAP. (LBS)	ANGLE	LIFTING CAP. (LBS)	ANGLE	LIFTING CAP. (LBS)	ANGLE	LIFTING CAP. (LBS)	ANGLE	LIFTING CAP. (LBS)	ANGLE	LIFTING CAP. (LBS)	ANGLE	LIFTING CAP. (LBS)	LOAD RADIUS (FT)
LENGTH	39.3 FT		53 FT		66 FT		79 FT		92 FT		105 FT		118 FT		131 FT		
6	74°	130000															6
8	70°	120000															8
10	67°	104870	74°	80000	77°	73200											10
12	64°	95630	71°	80000	76°	68990	78°	54510									12
15	59°	84050	68°	74250	73°	62490	76°	49640	79°	38040							15
20	50°	43880	62°	45410	68°	46260	72°	43090	75°	33510	78°	28990					20
25	40°	27620	55°	28960	63°	29670	69°	30140	72°	29440	75°	25810	77°	22810			25
30	26°	18940	49°	20230	58°	20880	65°	21300	69°	21600	72°	21820	75°	20770	77°	18180	30
35			41°	14810	53°	15430	61°	15830	66°	16110	69°	16310	73°	16470	75°	16590	35
40			31°	11090	47°	11720	56°	12100	62°	12370	66°	12560	70°	12710	73°	12820	40
45			18°	8350	41°	9020	52°	9400	58°	9660	63°	9840	67°	9980	70°	10090	45
50					35°	6960	47°	7350	55°	7600	60°	7780	65°	7920	68°	8020	50
55					28°	5330	41°	5730	51°	5990	57°	6160	62°	6300	66°	6400	55
60					18°	3950	35°	4430	46°	4680	54°	4860	59°	4990	63°	5090	60
65							28°	3340	42°	3610	50°	3790	56°	3920	61°	4020	65
70							18°	2420	36°	2700	46°	2890	53°	3020	58°	3120	70
75									30°	1930	42°	2120	50°	2250	55°	2350	75
80									23°	1260	38°	1460	46°	1590	52°	1690	80
85											33°	880	43°	1020	49°	1120	85
90																	90
95																	95
100																	100
105																	105
110																	110
115																	115
120																	120
125																	125
130																	130
DEDUCTIONS FOR MAIN BOOM CAPACITIES	0°	15900	0°	7450	0°	3900	0°	1900	0°	400	0°	0	0°	0	0°	0	
		1570		1140		920		770		660		580		520		460	STOWED
		3510		3240		3100		3010		2940		2890		2850		2820	RET
		3910		3530		3340		3200		3110		3040		2980		2940	EXT
	2620		2420		2320		2250		2200		2170		2140		2120	FIXED	

CODE 43

MAIN BOOM

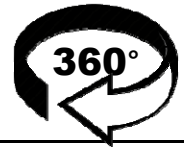
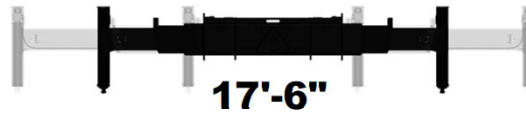

LOAD RADIUS (FT)	ANGLE	LIFTING CAP. (LBS)	ANGLE	LIFTING CAP. (LBS)	ANGLE	LIFTING CAP. (LBS)	ANGLE	LIFTING CAP. (LBS)	ANGLE	LIFTING CAP. (LBS)	ANGLE	LIFTING CAP. (LBS)	ANGLE	LIFTING CAP. (LBS)	ANGLE	LIFTING CAP. (LBS)	LOAD RADIUS (FT)
LENGTH	39.3 FT		53 FT		66 FT		79 FT		92 FT		105 FT		118 FT		131 FT		
6	74°	130000															6
8	70°	120000															8
10	67°	104870	74°	80000	77°	73200											10
12	64°	95630	71°	80000	76°	68990	78°	54510									12
15	59°	82760	68°	74250	73°	62490	76°	49640	79°	38040							15
20	50°	42070	62°	43610	68°	44450	72°	43090	75°	33510	78°	28990					20
25	40°	26370	55°	27710	63°	28420	69°	28890	72°	29230	75°	25810	77°	22810			25
30	26°	17980	49°	19270	58°	19930	65°	20350	69°	20650	72°	20870	75°	20770	77°	18180	30
35			41°	14030	53°	14660	61°	15060	66°	15330	69°	15540	73°	15700	75°	15820	35
40			31°	10440	47°	11070	56°	11450	62°	11720	66°	11910	70°	12060	73°	12170	40
45			18°	7790	41°	8460	52°	8840	58°	9100	63°	9280	67°	9420	70°	9530	45
50					35°	6470	47°	6860	55°	7110	60°	7290	65°	7430	68°	7530	50
55					28°	4890	41°	5290	51°	5550	57°	5730	62°	5860	66°	5960	55
60					18°	3550	35°	4030	46°	4290	54°	4470	59°	4600	63°	4700	60
65							28°	2980	42°	3250	50°	3430	56°	3560	61°	3660	65
70							18°	2090	36°	2370	46°	2560	53°	2690	58°	2790	70
75									30°	1630	42°	1810	50°	1950	55°	2040	75
80									23°	970	38°	1170	46°	1310	52°	1410	80
85															49°	850	85
90																	90
95																	95
100																	100
105																	105
110																	110
115																	115
120																	120
125																	125
130																	130
DEDUCTIONS FOR MAIN BOOM CAPACITIES	0°	15050	0°	6900	0°	3500	0°	1550	0°	150	0°	0	0°	0	0°	0	
		1570		1140		920		770		660		580		520		460	STOWED
		3510		3240		3100		3010		2940		2890		2850		2820	RET
		3910		3530		3340		3200		3110		3040		2980		2940	EXT
	2620		2420		2320		2250		2200		2170		2140		2120	FIXED	

CODE 44

MAIN BOOM

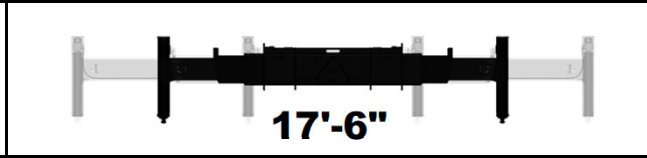
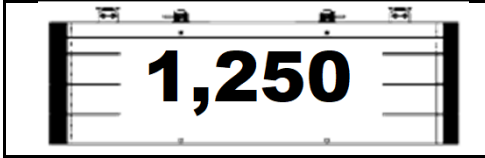

LOAD RADIUS (FT)	ANGLE	LIFTING CAP. (LBS)	ANGLE	LIFTING CAP. (LBS)	ANGLE	LIFTING CAP. (LBS)	ANGLE	LIFTING CAP. (LBS)	ANGLE	LIFTING CAP. (LBS)	ANGLE	LIFTING CAP. (LBS)	ANGLE	LIFTING CAP. (LBS)	ANGLE	LIFTING CAP. (LBS)	LOAD RADIUS (FT)
LENGTH	39.3 FT		53 FT		66 FT		79 FT		92 FT		105 FT		118 FT		131 FT		
6	74°	130000															6
8	70°	120000															8
10	67°	104870	74°	80000	77°	73200											10
12	64°	95630	71°	80000	76°	68990	78°	54510									12
15	59°	79520	68°	74250	73°	62490	76°	49640	79°	38040							15
20	50°	40270	62°	41810	68°	42650	72°	43090	75°	33510	78°	28990					20
25	40°	25120	55°	26460	63°	27180	69°	27640	72°	27980	75°	25810	77°	22810			25
30	26°	17030	49°	18320	58°	18970	65°	19400	69°	19690	72°	19920	75°	20090	77°	18180	30
35			41°	13260	53°	13890	61°	14290	66°	14560	69°	14770	73°	14920	75°	15050	35
40			31°	9800	47°	10420	56°	10810	62°	11070	66°	11260	70°	11410	73°	11530	40
45			18°	7230	41°	7900	52°	8280	58°	8540	63°	8720	67°	8860	70°	8970	45
50					35°	5980	47°	6360	55°	6620	60°	6800	65°	6930	68°	7040	50
55					28°	4460	41°	4860	51°	5110	57°	5290	62°	5420	66°	5520	55
60					18°	3160	35°	3640	46°	3890	54°	4070	59°	4200	63°	4300	60
65							28°	2620	42°	2890	50°	3070	56°	3200	61°	3300	65
70							18°	1750	36°	2040	46°	2220	53°	2360	58°	2450	70
75									30°	1320	42°	1510	50°	1640	55°	1740	75
80											38°	890	46°	1020	52°	1120	80
85																	85
90																	90
95																	95
100																	100
105																	105
110																	110
115																	115
120																	120
125																	125
130																	130
DEDUCTIONS FOR MAIN BOOM CAPACITIES	0°	14200	0°	6350	0°	3100	0°	1250	0°	0	0°	0	0°	0	0°	0	
		1570		1140		920		770		660		580		520		460	STOWED
		3510		3240		3100		3010		2940		2890		2850		2820	RET
		3910		3530		3340		3200		3110		3040		2980		2940	EXT
	2620		2420		2320		2250		2200		2170		2140		2120	FIXED	

CODE 45

MAIN BOOM

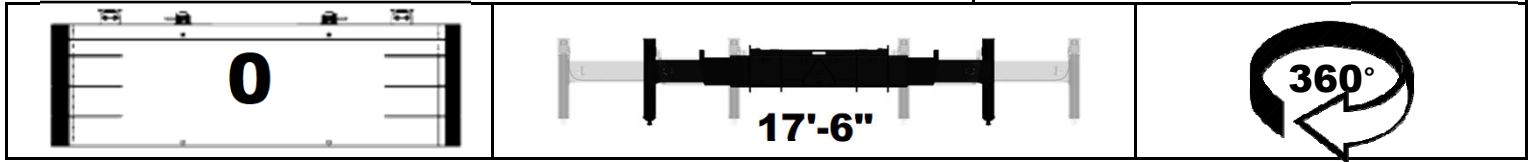

LOAD RADIUS (FT)	ANGLE	LIFTING CAP. (LBS)	ANGLE	LIFTING CAP. (LBS)	ANGLE	LIFTING CAP. (LBS)	ANGLE	LIFTING CAP. (LBS)	ANGLE	LIFTING CAP. (LBS)	ANGLE	LIFTING CAP. (LBS)	ANGLE	LIFTING CAP. (LBS)	ANGLE	LIFTING CAP. (LBS)	LOAD RADIUS (FT)
LENGTH	39.3 FT		53 FT		66 FT		79 FT		92 FT		105 FT		118 FT		131 FT		
6	74°	130000															6
8	70°	120000															8
10	67°	104870	74°	80000	77°	73200											10
12	64°	95630	71°	80000	76°	68990	78°	54510									12
15	59°	76270	68°	74250	73°	62490	76°	49640	79°	38040							15
20	50°	38470	62°	40000	68°	40850	72°	41410	75°	33510	78°	28990					20
25	40°	23880	55°	25210	63°	25930	69°	26400	72°	26730	75°	25810	77°	22810			25
30	26°	16070	49°	17370	58°	18020	65°	18440	69°	18740	72°	18960	75°	19130	77°	18180	30
35			41°	12490	53°	13120	61°	13510	66°	13790	69°	13990	73°	14150	75°	14280	35
40			31°	9150	47°	9770	56°	10160	62°	10420	66°	10610	70°	10760	73°	10880	40
45			18°	6680	41°	7340	52°	7720	58°	7980	63°	8160	67°	8300	70°	8420	45
50					35°	5490	47°	5870	55°	6130	60°	6310	65°	6440	68°	6550	50
55					28°	4020	41°	4420	51°	4670	57°	4850	62°	4980	66°	5090	55
60					18°	2760	35°	3240	46°	3500	54°	3670	59°	3810	63°	3910	60
65							28°	2260	42°	2530	50°	2710	56°	2840	61°	2940	65
70							18°	1420	36°	1710	46°	1890	53°	2020	58°	2120	70
75									30°	1010	42°	1200	50°	1330	55°	1430	75
80															52°	840	80
85																	85
90																	90
95																	95
100																	100
105																	105
110																	110
115																	115
120																	120
125																	125
130																	130
DEDUCTIONS FOR MAIN BOOM CAPACITIES	0°	13350	0°	5850	0°	2700	0°	950	0°	0	0°	0	0°	0	0°	0	
		1570		1140		920		770		660		580		520		460	STOWED
		3510		3240		3100		3010		2940		2890		2850		2820	RET
		3910		3530		3340		3200		3110		3040		2980		2940	EXT
	2620		2420		2320		2250		2200		2170		2140		2120	FIXED	

CODE 46

MAIN BOOM

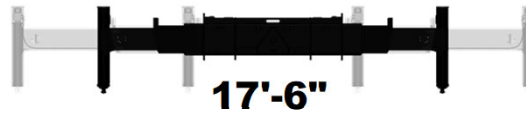

LOAD RADIUS (FT)	ANGLE	LIFTING CAP. (LBS)	ANGLE	LIFTING CAP. (LBS)	ANGLE	LIFTING CAP. (LBS)	ANGLE	LIFTING CAP. (LBS)	ANGLE	LIFTING CAP. (LBS)	ANGLE	LIFTING CAP. (LBS)	ANGLE	LIFTING CAP. (LBS)	ANGLE	LIFTING CAP. (LBS)	LOAD RADIUS (FT)
LENGTH	39.3 FT		53 FT		66 FT		79 FT		92 FT		105 FT		118 FT		131 FT		
6	74°	130000															6
8	70°	120000															8
10	67°	104870	74°	80000	77°	73200											10
12	64°	95630	71°	80000	76°	68990	78°	54510									12
15	59°	84050	68°	74250	73°	62490	76°	49640	79°	38040							15
20	50°	65540	62°	62410	68°	53070	72°	43090	75°	33510	78°	28990					20
25	40°	50810	55°	51800	63°	46050	69°	37560	72°	29440	75°	25810	77°	22810			25
30	26°	40810	49°	41860	58°	40230	65°	33320	69°	26050	72°	23390	75°	20770	77°	18180	30
35			41°	34600	53°	35220	61°	29630	66°	23500	69°	21000	73°	18830	75°	16770	35
40			31°	27430	47°	28090	56°	26450	62°	21000	66°	18910	70°	17110	73°	15360	40
45			18°	22260	41°	22950	52°	23350	58°	18920	63°	17130	67°	15520	70°	14070	45
50					35°	19090	47°	19490	55°	17110	60°	15540	65°	14150	68°	12900	50
55					28°	16070	41°	16480	51°	15570	57°	14150	62°	12930	66°	12100	55
60					18°	13570	35°	14060	46°	14210	54°	12920	59°	12100	63°	11110	60
65							28°	12080	42°	12350	50°	12100	56°	11100	61°	10190	65
70							18°	10410	36°	10700	46°	10890	53°	10190	58°	9370	70
75									30°	9300	42°	9490	50°	9360	55°	8620	75
80									23°	8090	38°	8290	46°	8430	52°	7940	80
85									11°	7010	33°	7250	43°	7390	49°	7310	85
90											27°	6330	39°	6480	46°	6580	90
95											19°	5510	34°	5670	43°	5770	95
100													29°	4950	39°	5060	100
105													23°	4300	36°	4420	105
110													14°	3700	31°	3830	110
115															26°	3310	115
120															19°	2820	120
125															6°	2350	125
130																	130
DEDUCTIONS FOR MAIN BOOM CAPACITIES	0°	30700	0°	18700	0°	13350	0°	8650	0°	6600	0°	4350	0°	3250	0°	0	
		1570		1140		920		770		660		580		520		460	STOWED
		3510		3240		3100		3010		2940		2890		2850		2820	RET
		3910		3530		3340		3200		3110		3040		2980		2940	EXT
	2620		2420		2320		2250		2200		2170		2140		2120	FIXED	

CODE 47

MAIN BOOM

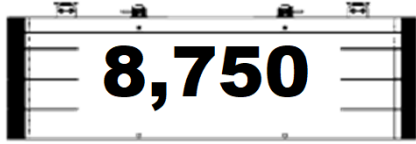

LOAD RADIUS (FT)	ANGLE	LIFTING CAP. (LBS)	ANGLE	LIFTING CAP. (LBS)	ANGLE	LIFTING CAP. (LBS)	ANGLE	LIFTING CAP. (LBS)	ANGLE	LIFTING CAP. (LBS)	ANGLE	LIFTING CAP. (LBS)	ANGLE	LIFTING CAP. (LBS)	ANGLE	LIFTING CAP. (LBS)	LOAD RADIUS (FT)
LENGTH	39.3 FT		53 FT		66 FT		79 FT		92 FT		105 FT		118 FT		131 FT		
6	74°	130000															6
8	70°	120000															8
10	67°	104870	74°	80000	77°	73200											10
12	64°	95630	71°	80000	76°	68990	78°	54510									12
15	59°	84050	68°	74250	73°	62490	76°	49640	79°	38040							15
20	50°	64890	62°	62410	68°	53070	72°	43090	75°	33510	78°	28990					20
25	40°	50280	55°	51280	63°	46050	69°	37560	72°	29440	75°	25810	77°	22810			25
30	26°	40370	49°	41420	58°	40230	65°	33320	69°	26050	72°	23390	75°	20770	77°	18180	30
35			41°	33740	53°	34400	61°	29630	66°	23500	69°	21000	73°	18830	75°	16770	35
40			31°	26720	47°	27370	56°	26450	62°	21000	66°	18910	70°	17110	73°	15360	40
45			18°	21650	41°	22340	52°	22730	58°	18920	63°	17130	67°	15520	70°	14070	45
50					35°	18550	47°	18950	55°	17110	60°	15540	65°	14150	68°	12900	50
55					28°	15590	41°	16000	51°	15570	57°	14150	62°	12930	66°	12100	55
60					18°	13140	35°	13630	46°	13900	54°	12920	59°	12100	63°	11110	60
65							28°	11690	42°	11960	50°	12100	56°	11100	61°	10190	65
70							18°	10050	36°	10340	46°	10530	53°	10190	58°	9370	70
75									30°	8970	42°	9160	50°	9290	55°	8620	75
80									23°	7780	38°	7980	46°	8120	52°	7940	80
85									11°	6730	33°	6960	43°	7100	49°	7200	85
90											27°	6060	39°	6210	46°	6310	90
95											19°	5250	34°	5410	43°	5520	95
100													29°	4710	39°	4820	100
105													23°	4070	36°	4190	105
110													14°	3480	31°	3620	110
115															26°	3100	115
120															19°	2620	120
125															6°	2170	125
130																	130
DEDUCTIONS FOR MAIN BOOM CAPACITIES	0°	30500	0°	18350	0°	12950	0°	8500	0°	6350	0°	4300	0°	3150	0°	0	
		1570		1140		920		770		660		580		520		460	STOWED
		3510		3240		3100		3010		2940		2890		2850		2820	RET
		3910		3530		3340		3200		3110		3040		2980		2940	EXT
	2620		2420		2320		2250		2200		2170		2140		2120	FIXED	

CODE 48

MAIN BOOM

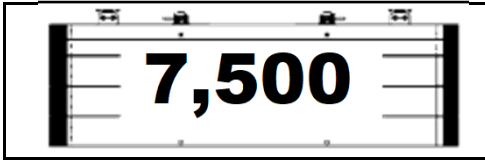

LOAD RADIUS (FT)	ANGLE	LIFTING CAP. (LBS)	ANGLE	LIFTING CAP. (LBS)	ANGLE	LIFTING CAP. (LBS)	ANGLE	LIFTING CAP. (LBS)	ANGLE	LIFTING CAP. (LBS)	ANGLE	LIFTING CAP. (LBS)	ANGLE	LIFTING CAP. (LBS)	ANGLE	LIFTING CAP. (LBS)	LOAD RADIUS (FT)
LENGTH	39.3 FT		53 FT		66 FT		79 FT		92 FT		105 FT		118 FT		131 FT		
6	74°	130000															6
8	70°	120000															8
10	67°	104870	74°	80000	77°	73200											10
12	64°	95630	71°	80000	76°	68990	78°	54510									12
15	59°	84050	68°	74250	73°	62490	76°	49640	79°	38040							15
20	50°	64240	62°	62410	68°	53070	72°	43090	75°	33510	78°	28990					20
25	40°	49760	55°	50750	63°	46050	69°	37560	72°	29440	75°	25810	77°	22810			25
30	26°	39930	49°	40980	58°	40230	65°	33320	69°	26050	72°	23390	75°	20770	77°	18180	30
35			41°	32880	53°	33540	61°	29630	66°	23500	69°	21000	73°	18830	75°	16770	35
40			31°	26000	47°	26650	56°	26450	62°	21000	66°	18910	70°	17110	73°	15360	40
45			18°	21030	41°	21720	52°	22120	58°	18920	63°	17130	67°	15520	70°	14070	45
50					35°	18010	47°	18410	55°	17110	60°	15540	65°	14150	68°	12900	50
55					28°	15110	41°	15520	51°	15570	57°	14150	62°	12930	66°	12100	55
60					18°	12710	35°	13200	46°	13470	54°	12920	59°	12100	63°	11110	60
65							28°	11300	42°	11570	50°	11750	56°	11100	61°	10190	65
70							18°	9690	36°	9980	46°	10170	53°	10190	58°	9370	70
75									30°	8640	42°	8830	50°	8960	55°	8620	75
80									23°	7470	38°	7670	46°	7810	52°	7910	80
85									11°	6440	33°	6670	43°	6810	49°	6920	85
90											27°	5790	39°	5940	46°	6040	90
95											19°	5000	34°	5160	43°	5270	95
100													29°	4470	39°	4580	100
105													23°	3840	36°	3960	105
110													14°	3270	31°	3400	110
115															26°	2900	115
120															19°	2430	120
125															6°	1980	125
130																	130
DEDUCTIONS FOR MAIN BOOM CAPACITIES	0°	30300	0°	18050	0°	12550	0°	8400	0°	6150	0°	4300	0°	3000	0°	0	
		1570		1140		920		770		660		580		520		460	STOWED
		3510		3240		3100		3010		2940		2890		2850		2820	RET
		3910		3530		3340		3200		3110		3040		2980		2940	EXT
	2620		2420		2320		2250		2200		2170		2140		2120	FIXED	

CODE 49

MAIN BOOM

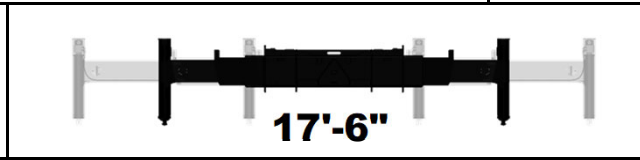
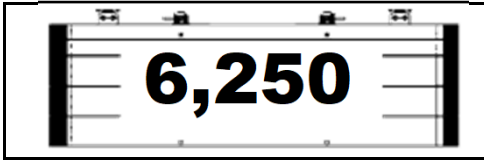

LOAD RADIUS (FT)	ANGLE	LIFTING CAP. (LBS)	ANGLE	LIFTING CAP. (LBS)	ANGLE	LIFTING CAP. (LBS)	ANGLE	LIFTING CAP. (LBS)	ANGLE	LIFTING CAP. (LBS)	ANGLE	LIFTING CAP. (LBS)	ANGLE	LIFTING CAP. (LBS)	ANGLE	LIFTING CAP. (LBS)	LOAD RADIUS (FT)
LENGTH	39.3 FT		53 FT		66 FT		79 FT		92 FT		105 FT		118 FT		131 FT		
6	74°	130000															6
8	70°	120000															8
10	67°	104870	74°	80000	77°	73200											10
12	64°	95630	71°	80000	76°	68990	78°	54510									12
15	59°	84050	68°	74250	73°	62490	76°	49640	79°	38040							15
20	50°	63580	62°	62410	68°	53070	72°	43090	75°	33510	78°	28990					20
25	40°	49240	55°	50230	63°	46050	69°	37560	72°	29440	75°	25810	77°	22810			25
30	26°	39490	49°	40540	58°	40230	65°	33320	69°	26050	72°	23390	75°	20770	77°	18180	30
35			41°	32020	53°	32680	61°	29630	66°	23500	69°	21000	73°	18830	75°	16770	35
40			31°	25280	47°	25930	56°	26340	62°	21000	66°	18910	70°	17110	73°	15360	40
45			18°	20420	41°	21110	52°	21500	58°	18920	63°	17130	67°	15520	70°	14070	45
50					35°	17480	47°	17870	55°	17110	60°	15540	65°	14150	68°	12900	50
55					28°	14630	41°	15040	51°	15300	57°	14150	62°	12930	66°	12100	55
60					18°	12280	35°	12770	46°	13040	54°	12920	59°	12100	63°	11110	60
65							28°	10900	42°	11180	50°	11360	56°	11100	61°	10190	65
70							18°	9330	36°	9620	46°	9810	53°	9950	58°	9370	70
75									30°	8300	42°	8500	50°	8630	55°	8620	75
80									23°	7160	38°	7370	46°	7500	52°	7610	80
85									11°	6150	33°	6380	43°	6530	49°	6630	85
90											27°	5520	39°	5670	46°	5770	90
95											19°	4750	34°	4910	43°	5010	95
100													29°	4230	39°	4340	100
105													23°	3620	36°	3740	105
110													14°	3050	31°	3190	110
115															26°	2690	115
120															19°	2230	120
125															6°	1790	125
130																	130
DEDUCTIONS FOR MAIN BOOM CAPACITIES	0°	30100	0°	17700	0°	12150	0°	8250	0°	5900	0°	4100	0°	2800	0°	0	
		1570		1140		920		770		660		580		520		460	STOWED
		3510		3240		3100		3010		2940		2890		2850		2820	RET
		3910		3530		3340		3200		3110		3040		2980		2940	EXT
	2620		2420		2320		2250		2200		2170		2140		2120	FIXED	

CODE 50

MAIN BOOM

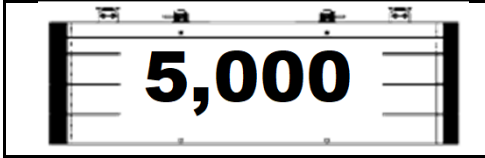

LOAD RADIUS (FT)	ANGLE	LIFTING CAP. (LBS)	ANGLE	LIFTING CAP. (LBS)	ANGLE	LIFTING CAP. (LBS)	ANGLE	LIFTING CAP. (LBS)	ANGLE	LIFTING CAP. (LBS)	ANGLE	LIFTING CAP. (LBS)	ANGLE	LIFTING CAP. (LBS)	ANGLE	LIFTING CAP. (LBS)	LOAD RADIUS (FT)
LENGTH	39.3 FT		53 FT		66 FT		79 FT		92 FT		105 FT		118 FT		131 FT		
6	74°	130000															6
8	70°	120000															8
10	67°	104870	74°	80000	77°	73200											10
12	64°	95630	71°	80000	76°	68990	78°	54510									12
15	59°	84050	68°	74250	73°	62490	76°	49640	79°	38040							15
20	50°	62930	62°	62410	68°	53070	72°	43090	75°	33510	78°	28990					20
25	40°	48710	55°	49700	63°	46050	69°	37560	72°	29440	75°	25810	77°	22810			25
30	26°	39050	49°	40100	58°	40230	65°	33320	69°	26050	72°	23390	75°	20770	77°	18180	30
35			41°	31160	53°	31820	61°	29630	66°	23500	69°	21000	73°	18830	75°	16770	35
40			31°	24560	47°	25220	56°	25620	62°	21000	66°	18910	70°	17110	73°	15360	40
45			18°	19800	41°	20490	52°	20890	58°	18920	63°	17130	67°	15520	70°	14070	45
50					35°	16940	47°	17330	55°	17110	60°	15540	65°	14150	68°	12900	50
55					28°	14150	41°	14560	51°	14820	57°	14150	62°	12930	66°	12100	55
60					18°	11850	35°	12340	46°	12610	54°	12790	59°	12100	63°	11110	60
65							28°	10510	42°	10790	50°	10970	56°	11100	61°	10190	65
70							18°	8970	36°	9270	46°	9450	53°	9590	58°	9370	70
75									30°	7970	42°	8170	50°	8300	55°	8400	75
80									23°	6860	38°	7060	46°	7200	52°	7300	80
85									11°	5860	33°	6100	43°	6240	49°	6340	85
90											27°	5250	39°	5400	46°	5500	90
95											19°	4490	34°	4650	43°	4760	95
100													29°	3990	39°	4100	100
105													23°	3390	36°	3510	105
110													14°	2840	31°	2970	110
115															26°	2490	115
120															19°	2040	120
125															6°	1600	125
130																	130
DEDUCTIONS FOR MAIN BOOM CAPACITIES	0°	29900	0°	17350	0°	11750	0°	8100	0°	5650	0°	3900	0°	2600	0°	0	
		1570		1140		920		770		660		580		520		460	STOWED
		3510		3240		3100		3010		2940		2890		2850		2820	RET
		3910		3530		3340		3200		3110		3040		2980		2940	EXT
	2620		2420		2320		2250		2200		2170		2140		2120	FIXED	

CODE 51

MAIN BOOM

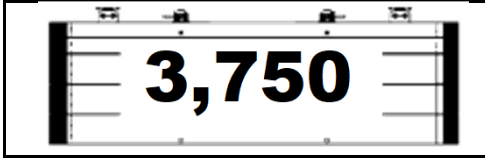

LOAD RADIUS (FT)	ANGLE	LIFTING CAP. (LBS)	ANGLE	LIFTING CAP. (LBS)	ANGLE	LIFTING CAP. (LBS)	ANGLE	LIFTING CAP. (LBS)	ANGLE	LIFTING CAP. (LBS)	ANGLE	LIFTING CAP. (LBS)	ANGLE	LIFTING CAP. (LBS)	ANGLE	LIFTING CAP. (LBS)	LOAD RADIUS (FT)
LENGTH	39.3 FT		53 FT		66 FT		79 FT		92 FT		105 FT		118 FT		131 FT		
6	74°	130000															6
8	70°	120000															8
10	67°	104870	74°	80000	77°	73200											10
12	64°	95630	71°	80000	76°	68990	78°	54510									12
15	59°	84050	68°	74250	73°	62490	76°	49640	79°	38040							15
20	50°	62280	62°	62410	68°	53070	72°	43090	75°	33510	78°	28990					20
25	40°	48190	55°	49180	63°	46050	69°	37560	72°	29440	75°	25810	77°	22810			25
30	26°	38560	49°	39660	58°	40180	65°	33320	69°	26050	72°	23390	75°	20770	77°	18180	30
35			41°	30290	53°	30950	61°	29630	66°	23500	69°	21000	73°	18830	75°	16770	35
40			31°	23840	47°	24500	56°	24900	62°	21000	66°	18910	70°	17110	73°	15360	40
45			18°	19190	41°	19880	52°	20270	58°	18920	63°	17130	67°	15520	70°	14070	45
50					35°	16400	47°	16790	55°	17060	60°	15540	65°	14150	68°	12900	50
55					28°	13670	41°	14090	51°	14350	57°	14150	62°	12930	66°	12100	55
60					18°	11420	35°	11910	46°	12170	54°	12360	59°	12100	63°	11110	60
65							28°	10120	42°	10390	50°	10580	56°	10710	61°	10190	65
70							18°	8610	36°	8910	46°	9090	53°	9230	58°	9330	70
75									30°	7640	42°	7830	50°	7970	55°	8070	75
80									23°	6550	38°	6750	46°	6890	52°	6990	80
85									11°	5580	33°	5810	43°	5950	49°	6050	85
90											27°	4980	39°	5130	46°	5230	90
95											19°	4240	34°	4400	43°	4510	95
100													29°	3750	39°	3860	100
105													23°	3160	36°	3280	105
110													14°	2620	31°	2760	110
115															26°	2280	115
120															19°	1840	120
125															6°	1420	125
130																	130
DEDUCTIONS FOR MAIN BOOM CAPACITIES	0°	29650	0°	17000	0°	11300	0°	7750	0°	5350	0°	3650	0°	2400	0°	0	
		1570		1140		920		770		660		580		520		460	STOWED
		3510		3240		3100		3010		2940		2890		2850		2820	RET
		3910		3530		3340		3200		3110		3040		2980		2940	EXT
	2620		2420		2320		2250		2200		2170		2140		2120	FIXED	

CODE 52

MAIN BOOM

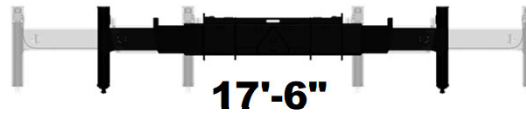

LOAD RADIUS (FT)	ANGLE	LIFTING CAP. (LBS)	ANGLE	LIFTING CAP. (LBS)	ANGLE	LIFTING CAP. (LBS)	ANGLE	LIFTING CAP. (LBS)	ANGLE	LIFTING CAP. (LBS)	ANGLE	LIFTING CAP. (LBS)	ANGLE	LIFTING CAP. (LBS)	ANGLE	LIFTING CAP. (LBS)	LOAD RADIUS (FT)
LENGTH	39.3 FT		53 FT		66 FT		79 FT		92 FT		105 FT		118 FT		131 FT		
6	74°	130000															6
8	70°	120000															8
10	67°	104870	74°	80000	77°	73200											10
12	64°	95630	71°	80000	76°	68990	78°	54510									12
15	59°	84050	68°	74250	73°	62490	76°	49640	79°	38040							15
20	50°	61630	62°	62410	68°	53070	72°	43090	75°	33510	78°	28990					20
25	40°	47660	55°	48650	63°	46050	69°	37560	72°	29440	75°	25810	77°	22810			25
30	26°	37480	49°	38850	58°	39550	65°	33320	69°	26050	72°	23390	75°	20770	77°	18180	30
35			41°	29430	53°	30090	61°	29630	66°	23500	69°	21000	73°	18830	75°	16770	35
40			31°	23130	47°	23780	56°	24180	62°	21000	66°	18910	70°	17110	73°	15360	40
45			18°	18570	41°	19260	52°	19660	58°	18920	63°	17130	67°	15520	70°	14070	45
50					35°	15860	47°	16260	55°	16520	60°	15540	65°	14150	68°	12900	50
55					28°	13190	41°	13610	51°	13870	57°	14050	62°	12930	66°	12100	55
60					18°	10990	35°	11480	46°	11740	54°	11930	59°	12060	63°	11110	60
65							28°	9730	42°	10000	50°	10190	56°	10320	61°	10190	65
70							18°	8250	36°	8550	46°	8730	53°	8870	58°	8970	70
75									30°	7310	42°	7500	50°	7640	55°	7740	75
80									23°	6240	38°	6440	46°	6580	52°	6680	80
85									11°	5290	33°	5520	43°	5660	49°	5770	85
90											27°	4710	39°	4860	46°	4960	90
95											19°	3990	34°	4150	43°	4250	95
100													29°	3510	39°	3620	100
105													23°	2940	36°	3060	105
110													14°	2410	31°	2540	110
115															26°	2080	115
120															19°	1640	120
125															6°	1230	125
130																	130
DEDUCTIONS FOR MAIN BOOM CAPACITIES	0°	29200	0°	16650	0°	10900	0°	7400	0°	5050	0°	3400	0°	2200	0°	0	
		1570		1140		920		770		660		580		520		460	STOWED
		3510		3240		3100		3010		2940		2890		2850		2820	RET
		3910		3530		3340		3200		3110		3040		2980		2940	EXT
	2620		2420		2320		2250		2200		2170		2140		2120	FIXED	

CODE 53

MAIN BOOM

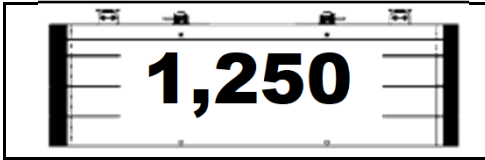

LOAD RADIUS (FT)	ANGLE	LIFTING CAP. (LBS)	ANGLE	LIFTING CAP. (LBS)	ANGLE	LIFTING CAP. (LBS)	ANGLE	LIFTING CAP. (LBS)	ANGLE	LIFTING CAP. (LBS)	ANGLE	LIFTING CAP. (LBS)	ANGLE	LIFTING CAP. (LBS)	ANGLE	LIFTING CAP. (LBS)	LOAD RADIUS (FT)
LENGTH	39.3 FT		53 FT		66 FT		79 FT		92 FT		105 FT		118 FT		131 FT		
6	74°	130000															6
8	70°	120000															8
10	67°	104870	74°	80000	77°	73200											10
12	64°	95630	71°	80000	76°	68990	78°	54510									12
15	59°	83550	68°	74250	73°	62490	76°	49640	79°	38040							15
20	50°	60980	62°	61950	68°	53070	72°	43090	75°	33510	78°	28990					20
25	40°	47140	55°	48130	63°	46050	69°	37560	72°	29440	75°	25810	77°	22810			25
30	26°	36400	49°	37780	58°	38470	65°	33320	69°	26050	72°	23390	75°	20770	77°	18180	30
35			41°	28570	53°	29230	61°	29630	66°	23500	69°	21000	73°	18830	75°	16770	35
40			31°	22410	47°	23060	56°	23460	62°	21000	66°	18910	70°	17110	73°	15360	40
45			18°	17950	41°	18650	52°	19040	58°	18920	63°	17130	67°	15520	70°	14070	45
50					35°	15320	47°	15720	55°	15980	60°	15540	65°	14150	68°	12900	50
55					28°	12720	41°	13130	51°	13390	57°	13570	62°	12930	66°	12100	55
60					18°	10560	35°	11050	46°	11310	54°	11500	59°	11630	63°	11110	60
65							28°	9340	42°	9610	50°	9800	56°	9930	61°	10030	65
70							18°	7890	36°	8190	46°	8380	53°	8510	58°	8610	70
75									30°	6980	42°	7170	50°	7310	55°	7410	75
80									23°	5930	38°	6140	46°	6270	52°	6380	80
85									11°	5000	33°	5240	43°	5380	49°	5480	85
90											27°	4440	39°	4590	46°	4700	90
95											19°	3730	34°	3890	43°	4000	95
100													29°	3270	39°	3380	100
105													23°	2710	36°	2830	105
110													14°	2190	31°	2330	110
115															26°	1870	115
120															19°	1450	120
125															6°	1040	125
130																	130
DEDUCTIONS FOR MAIN BOOM CAPACITIES	0°	28700	0°	16350	0°	10450	0°	7050	0°	4800	0°	3150	0°	1950	0°	0	
		1570		1140		920		770		660		580		520		460	STOWED
		3510		3240		3100		3010		2940		2890		2850		2820	RET
		3910		3530		3340		3200		3110		3040		2980		2940	EXT
	2620		2420		2320		2250		2200		2170		2140		2120	FIXED	

CODE 54

MAIN BOOM

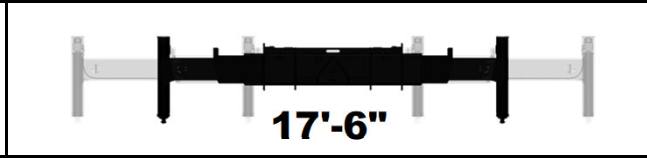
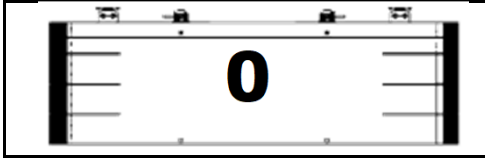

LOAD RADIUS (FT)	ANGLE	LIFTING CAP. (LBS)	ANGLE	LIFTING CAP. (LBS)	ANGLE	LIFTING CAP. (LBS)	ANGLE	LIFTING CAP. (LBS)	ANGLE	LIFTING CAP. (LBS)	ANGLE	LIFTING CAP. (LBS)	ANGLE	LIFTING CAP. (LBS)	ANGLE	LIFTING CAP. (LBS)	LOAD RADIUS (FT)
LENGTH	39.3 FT		53 FT		66 FT		79 FT		92 FT		105 FT		118 FT		131 FT		
6	74°	130000															6
8	70°	120000															8
10	67°	104870	74°	80000	77°	73200											10
12	64°	95630	71°	80000	76°	68990	78°	54510									12
15	59°	82700	68°	74250	73°	62490	76°	49640	79°	38040							15
20	50°	60330	62°	61300	68°	53070	72°	43090	75°	33510	78°	28990					20
25	40°	46610	55°	47600	63°	46050	69°	37560	72°	29440	75°	25810	77°	22810			25
30	26°	35330	49°	36700	58°	37400	65°	33320	69°	26050	72°	23390	75°	20770	77°	18180	30
35			41°	27710	53°	28370	61°	28790	66°	23500	69°	21000	73°	18830	75°	16770	35
40			31°	21690	47°	22350	56°	22750	62°	21000	66°	18910	70°	17110	73°	15360	40
45			18°	17340	41°	18030	52°	18430	58°	18690	63°	17130	67°	15520	70°	14070	45
50					35°	14780	47°	15180	55°	15440	60°	15540	65°	14150	68°	12900	50
55					28°	12240	41°	12650	51°	12910	57°	13100	62°	12930	66°	12100	55
60					18°	10130	35°	10620	46°	10880	54°	11070	59°	11200	63°	11110	60
65							28°	8950	42°	9220	50°	9400	56°	9540	61°	9640	65
70							18°	7540	36°	7830	46°	8020	53°	8150	58°	8250	70
75									30°	6650	42°	6840	50°	6980	55°	7080	75
80									23°	5630	38°	5830	46°	5970	52°	6070	80
85									11°	4720	33°	4950	43°	5090	49°	5190	85
90											27°	4170	39°	4320	46°	4430	90
95											19°	3480	34°	3640	43°	3750	95
100													29°	3030	39°	3140	100
105													23°	2480	36°	2600	105
110													14°	1980	31°	2110	110
115															26°	1670	115
120															19°	1250	120
125															6°	860	125
130																	130
DEDUCTIONS FOR MAIN BOOM CAPACITIES	0°	28200	0°	15900	0°	10050	0°	6750	0°	4500	0°	2900	0°	1750	0°	0	
		1570		1140		920		770		660		580		520		460	STOWED
		3510		3240		3100		3010		2940		2890		2850		2820	RET
		3910		3530		3340		3200		3110		3040		2980		2940	EXT
	2620		2420		2320		2250		2200		2170		2140		2120	FIXED	

CODE 55

MAIN BOOM



10,000

7'-10"

360°

LOAD RADIUS (FT)	ANGLE	LIFTING CAP. (LBS)	ANGLE	LIFTING CAP. (LBS)	ANGLE	LIFTING CAP. (LBS)	ANGLE	LIFTING CAP. (LBS)	ANGLE	LIFTING CAP. (LBS)	ANGLE	LIFTING CAP. (LBS)	ANGLE	LIFTING CAP. (LBS)	ANGLE	LIFTING CAP. (LBS)	LOAD RADIUS (FT)
LENGTH	39.3 FT		53 FT		66 FT		79 FT		92 FT		105 FT		118 FT		131 FT		
6	74°	130000															6
8	70°	91710															8
10	67°	58600	74°	60220	77°	61130											10
12	64°	41910	71°	43300	76°	44080	78°	44610									12
15	59°	28190	68°	29390	73°	30060	76°	30510	79°	30830							15
20	50°	16670	62°	17750	68°	18330	72°	18720	75°	18990	78°	19200					20
25	40°	10590	55°	11620	63°	12170	69°	12520	72°	12770	75°	12950	77°	13100			25
30	26°	6780	49°	7830	58°	8360	65°	8700	69°	8930	72°	9100	75°	9240	77°	9340	30
35			41°	5240	53°	5770	61°	6100	66°	6330	69°	6490	73°	6620	75°	6720	35
40			31°	3350	47°	3890	56°	4220	62°	4440	66°	4600	70°	4730	73°	4820	40
45			18°	1870	41°	2460	52°	2790	58°	3010	63°	3170	67°	3290	70°	3380	45
50					35°	1330	47°	1670	55°	1890	60°	2050	65°	2170	68°	2260	50
55							41°	760	51°	990	57°	1150	62°	1260	66°	1350	55
60																	60
65																	65
70																	70
75																	75
80																	80
85																	85
90																	90
95																	95
100																	100
105																	105
110																	110
115																	115
120																	120
125																	125
130																	130
DEDUCTIONS FOR MAIN BOOM CAPACITIES	0°	5300	0°	1350	0°	0	0°	0	0°	0	0°	0	0°	0	0°	0	
		1570		1140		920		770		660		580		520		460	STOWED
		3510		3240		3100		3010		2940		2890		2850		2820	RET
		3910		3530		3340		3200		3110		3040		2980		2940	EXT
	2620		2420		2320		2250		2200		2170		2140		2120	FIXED	

CODE 56

MAIN BOOM

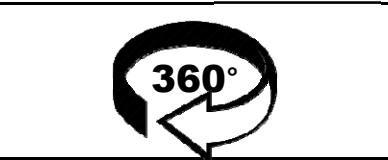
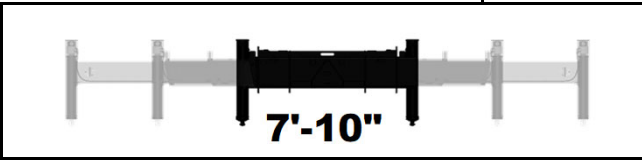
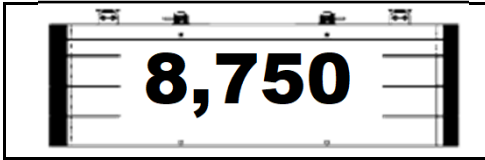

LOAD RADIUS (FT)	ANGLE	LIFTING CAP. (LBS)	ANGLE	LIFTING CAP. (LBS)	ANGLE	LIFTING CAP. (LBS)	ANGLE	LIFTING CAP. (LBS)	ANGLE	LIFTING CAP. (LBS)	ANGLE	LIFTING CAP. (LBS)	ANGLE	LIFTING CAP. (LBS)	ANGLE	LIFTING CAP. (LBS)	LOAD RADIUS (FT)
LENGTH	39.3 FT		53 FT		66 FT		79 FT		92 FT		105 FT		118 FT		131 FT		
6	74°	130000															6
8	70°	87900															8
10	67°	56050	74°	57660	77°	58580											10
12	64°	39990	71°	41380	76°	42160	78°	42690									12
15	59°	26790	68°	27990	73°	28670	76°	29110	79°	29440							15
20	50°	15710	62°	16790	68°	17370	72°	17760	75°	18030	78°	18230					20
25	40°	9850	55°	10890	63°	11430	69°	11790	72°	12040	75°	12220	77°	12360			25
30	26°	6180	49°	7230	58°	7760	65°	8100	69°	8340	72°	8510	75°	8640	77°	8750	30
35			41°	4740	53°	5270	61°	5600	66°	5830	69°	6000	73°	6120	75°	6220	35
40			31°	2920	47°	3460	56°	3790	62°	4010	66°	4180	70°	4300	73°	4390	40
45			18°	1500	41°	2080	52°	2420	58°	2640	63°	2800	67°	2920	70°	3010	45
50					35°	1000	47°	1340	55°	1560	60°	1720	65°	1830	68°	1920	50
55											57°	840	62°	960	66°	1050	55
60																	60
65																	65
70																	70
75																	75
80																	80
85																	85
90																	90
95																	95
100																	100
105																	105
110																	110
115																	115
120																	120
125																	125
130																	130
DEDUCTIONS FOR MAIN BOOM CAPACITIES	0°	4750	0°	1000	0°	0	0°	0	0°	0	0°	0	0°	0	0°	0	
		1570		1140		920		770		660		580		520		460	STOWED
		3510		3240		3100		3010		2940		2890		2850		2820	RET
		3910		3530		3340		3200		3110		3040		2980		2940	EXT
	2620		2420		2320		2250		2200		2170		2140		2120	FIXED	

CODE 57

MAIN BOOM



7,500

7'-10"

360°

LOAD RADIUS (FT)	ANGLE	LIFTING CAP. (LBS)	ANGLE	LIFTING CAP. (LBS)	ANGLE	LIFTING CAP. (LBS)	ANGLE	LIFTING CAP. (LBS)	ANGLE	LIFTING CAP. (LBS)	ANGLE	LIFTING CAP. (LBS)	ANGLE	LIFTING CAP. (LBS)	ANGLE	LIFTING CAP. (LBS)	LOAD RADIUS (FT)
LENGTH	39.3 FT		53 FT		66 FT		79 FT		92 FT		105 FT		118 FT		131 FT		
6	74°	130000															6
8	70°	84090															8
10	67°	53490	74°	55110	77°	56030											10
12	64°	38070	71°	39460	76°	40240	78°	40770									12
15	59°	25390	68°	26600	73°	27270	76°	27720	79°	28040							15
20	50°	14750	62°	15820	68°	16410	72°	16790	75°	17070	78°	17270					20
25	40°	9120	55°	10150	63°	10700	69°	11050	72°	11300	75°	11490	77°	11630			25
30	26°	5590	49°	6640	58°	7170	65°	7510	69°	7740	72°	7920	75°	8050	77°	8150	30
35			41°	4250	53°	4770	61°	5100	66°	5330	69°	5500	73°	5620	75°	5720	35
40			31°	2490	47°	3030	56°	3360	62°	3580	66°	3750	70°	3870	73°	3960	40
45			18°	1120	41°	1710	52°	2040	58°	2260	63°	2420	67°	2540	70°	2630	45
50							47°	1000	55°	1220	60°	1380	65°	1500	68°	1590	50
55																	55
60																	60
65																	65
70																	70
75																	75
80																	80
85																	85
90																	90
95																	95
100																	100
105																	105
110																	110
115																	115
120																	120
125																	125
130																	130
DEDUCTIONS FOR MAIN BOOM CAPACITIES	0°	4200	0°	650	0°	0	0°	0	0°	0	0°	0	0°	0	0°	0	
		1570		1140		920		770		660		580		520		460	STOWED
		3510		3240		3100		3010		2940		2890		2850		2820	RET
		3910		3530		3340		3200		3110		3040		2980		2940	EXT
	2620		2420		2320		2250		2200		2170		2140		2120	FIXED	

CODE 58

MAIN BOOM

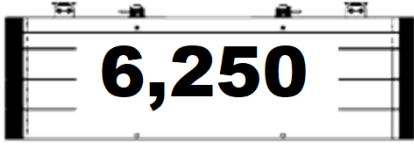

LOAD RADIUS (FT)	ANGLE	LIFTING CAP. (LBS)	ANGLE	LIFTING CAP. (LBS)	ANGLE	LIFTING CAP. (LBS)	ANGLE	LIFTING CAP. (LBS)	ANGLE	LIFTING CAP. (LBS)	ANGLE	LIFTING CAP. (LBS)	ANGLE	LIFTING CAP. (LBS)	ANGLE	LIFTING CAP. (LBS)	LOAD RADIUS (FT)
LENGTH	39.3 FT		53 FT		66 FT		79 FT		92 FT		105 FT		118 FT		131 FT		
6	74°	130000															6
8	70°	80280															8
10	67°	50940	74°	52560	77°	53470											10
12	64°	36150	71°	37540	76°	38320	78°	38850									12
15	59°	23990	68°	25200	73°	25870	76°	26320	79°	26640							15
20	50°	13780	62°	14860	68°	15440	72°	15830	75°	16100	78°	16310					20
25	40°	8380	55°	9420	63°	9960	69°	10320	72°	10570	75°	10750	77°	10890			25
30	26°	4990	49°	6050	58°	6580	65°	6920	69°	7150	72°	7320	75°	7460	77°	7560	30
35			41°	3750	53°	4270	61°	4610	66°	4830	69°	5000	73°	5130	75°	5220	35
40			31°	2060	47°	2600	56°	2930	62°	3160	66°	3320	70°	3440	73°	3530	40
45					41°	1330	52°	1660	58°	1880	63°	2040	67°	2160	70°	2250	45
50									55°	890	60°	1040	65°	1160	68°	1250	50
55																	55
60																	60
65																	65
70																	70
75																	75
80																	80
85																	85
90																	90
95																	95
100																	100
105																	105
110																	110
115																	115
120																	120
125																	125
130																	130
DEDUCTIONS FOR MAIN BOOM CAPACITIES	0°	3650	0°	0	0°	0	0°	0	0°	0	0°	0	0°	0	0°	0	
		1570		1140		920		770		660		580		520		460	STOWED
		3510		3240		3100		3010		2940		2890		2850		2820	RET
		3910		3530		3340		3200		3110		3040		2980		2940	EXT
	2620		2420		2320		2250		2200		2170		2140		2120	FIXED	

CODE 59

MAIN BOOM

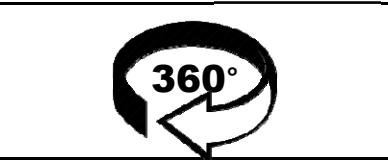
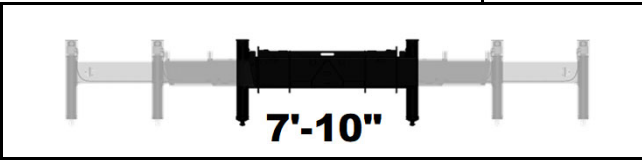
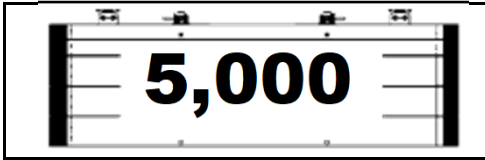

LOAD RADIUS (FT)	ANGLE	LIFTING CAP. (LBS)	ANGLE	LIFTING CAP. (LBS)	ANGLE	LIFTING CAP. (LBS)	ANGLE	LIFTING CAP. (LBS)	ANGLE	LIFTING CAP. (LBS)	ANGLE	LIFTING CAP. (LBS)	ANGLE	LIFTING CAP. (LBS)	ANGLE	LIFTING CAP. (LBS)	LOAD RADIUS (FT)
LENGTH	39.3 FT		53 FT		66 FT		79 FT		92 FT		105 FT		118 FT		131 FT		
6	74°	130000															6
8	70°	76470															8
10	67°	48390	74°	50000	77°	50920											10
12	64°	34230	71°	35620	76°	36400	78°	36930									12
15	59°	22590	68°	23800	73°	24470	76°	24920	79°	25240							15
20	50°	12820	62°	13900	68°	14480	72°	14870	75°	15140	78°	15340					20
25	40°	7650	55°	8680	63°	9230	69°	9580	72°	9830	75°	10020	77°	10160			25
30	26°	4400	49°	5450	58°	5980	65°	6320	69°	6560	72°	6730	75°	6860	77°	6970	30
35			41°	3250	53°	3780	61°	4110	66°	4340	69°	4500	73°	4630	75°	4730	35
40			31°	1630	47°	2170	56°	2500	62°	2730	66°	2890	70°	3010	73°	3100	40
45					41°	950	52°	1290	58°	1510	63°	1670	67°	1790	70°	1880	45
50													65°	830	68°	920	50
55																	55
60																	60
65																	65
70																	70
75																	75
80																	80
85																	85
90																	90
95																	95
100																	100
105																	105
110																	110
115																	115
120																	120
125																	125
130																	130
DEDUCTIONS FOR MAIN BOOM CAPACITIES	0°	3150	0°	0	0°	0	0°	0	0°	0	0°	0	0°	0	0°	0	
		1570		1140		920		770		660		580		520		460	STOWED
		3510		3240		3100		3010		2940		2890		2850		2820	RET
		3910		3530		3340		3200		3110		3040		2980		2940	EXT
	2620		2420		2320		2250		2200		2170		2140		2120	FIXED	

CODE 60

MAIN BOOM

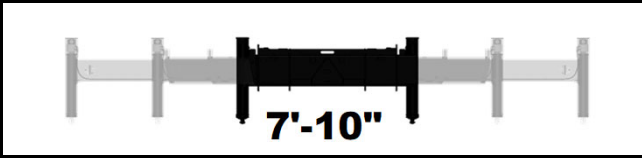
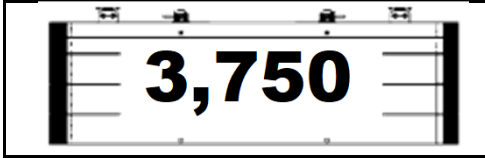

LOAD RADIUS (FT)	ANGLE	LIFTING CAP. (LBS)	ANGLE	LIFTING CAP. (LBS)	ANGLE	LIFTING CAP. (LBS)	ANGLE	LIFTING CAP. (LBS)	ANGLE	LIFTING CAP. (LBS)	ANGLE	LIFTING CAP. (LBS)	ANGLE	LIFTING CAP. (LBS)	ANGLE	LIFTING CAP. (LBS)	LOAD RADIUS (FT)
LENGTH	39.3 FT		53 FT		66 FT		79 FT		92 FT		105 FT		118 FT		131 FT		
6	74°	130000															6
8	70°	72660															8
10	67°	45830	74°	47450	77°	48370											10
12	64°	32310	71°	33700	76°	34480	78°	35010									12
15	59°	21190	68°	22400	73°	23070	76°	23520	79°	23840							15
20	50°	11860	62°	12930	68°	13520	72°	13900	75°	14180	78°	14380					20
25	40°	6920	55°	7950	63°	8490	69°	8850	72°	9100	75°	9280	77°	9420			25
30	26°	3810	49°	4860	58°	5390	65°	5730	69°	5960	72°	6140	75°	6270	77°	6370	30
35			41°	2750	53°	3280	61°	3610	66°	3840	69°	4000	73°	4130	75°	4230	35
40			31°	1210	47°	1750	56°	2070	62°	2300	66°	2460	70°	2580	73°	2680	40
45							52°	910	58°	1130	63°	1290	67°	1410	70°	1500	45
50																	50
55																	55
60																	60
65																	65
70																	70
75																	75
80																	80
85																	85
90																	90
95																	95
100																	100
105																	105
110																	110
115																	115
120																	120
125																	125
130																	130
DEDUCTIONS FOR MAIN BOOM CAPACITIES	0°	2600	0°	0	0°	0	0°	0	0°	0	0°	0	0°	0	0°	0	
		1570		1140		920		770		660		580		520		460	STOWED
		3510		3240		3100		3010		2940		2890		2850		2820	RET
		3910		3530		3340		3200		3110		3040		2980		2940	EXT
	2620		2420		2320		2250		2200		2170		2140		2120	FIXED	

CODE 61

MAIN BOOM

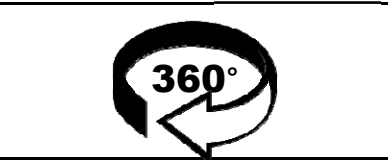
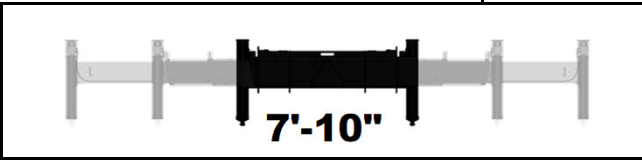
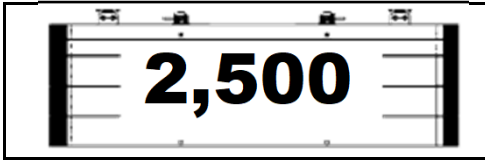

LOAD RADIUS (FT)	ANGLE	LIFTING CAP. (LBS)	ANGLE	LIFTING CAP. (LBS)	ANGLE	LIFTING CAP. (LBS)	ANGLE	LIFTING CAP. (LBS)	ANGLE	LIFTING CAP. (LBS)	ANGLE	LIFTING CAP. (LBS)	ANGLE	LIFTING CAP. (LBS)	ANGLE	LIFTING CAP. (LBS)	LOAD RADIUS (FT)
LENGTH	39.3 FT		53 FT		66 FT		79 FT		92 FT		105 FT		118 FT		131 FT		
6	74°	130000															6
8	70°	68840															8
10	67°	43280	74°	44900	77°	45820											10
12	64°	30400	71°	31780	76°	32560	78°	33090									12
15	59°	19790	68°	21000	73°	21670	76°	22120	79°	22440							15
20	50°	10890	62°	11970	68°	12550	72°	12940	75°	13210	78°	13420					20
25	40°	6180	55°	7210	63°	7760	69°	8110	72°	8360	75°	8550	77°	8690			25
30	26°	3210	49°	4270	58°	4800	65°	5140	69°	5370	72°	5540	75°	5680	77°	5780	30
35			41°	2250	53°	2780	61°	3110	66°	3340	69°	3510	73°	3630	75°	3730	35
40			31°	780	47°	1320	56°	1650	62°	1870	66°	2030	70°	2150	73°	2250	40
45											63°	910	67°	1030	70°	1120	45
50																	50
55																	55
60																	60
65																	65
70																	70
75																	75
80																	80
85																	85
90																	90
95																	95
100																	100
105																	105
110																	110
115																	115
120																	120
125																	125
130																	130
DEDUCTIONS FOR MAIN BOOM CAPACITIES	0°	2050	0°	0	0°	0	0°	0	0°	0	0°	0	0°	0	0°	0	
		1570		1140		920		770		660		580		520		460	STOWED
		3510		3240		3100		3010		2940		2890		2850		2820	RET
		3910		3530		3340		3200		3110		3040		2980		2940	EXT
	2620		2420		2320		2250		2200		2170		2140		2120	FIXED	

CODE 62

MAIN BOOM

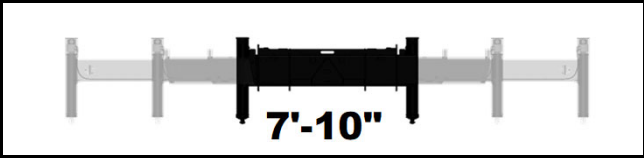
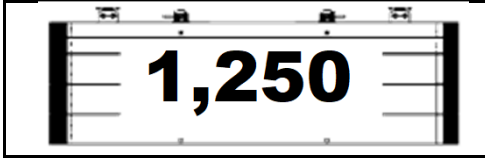

LOAD RADIUS (FT)	ANGLE	LIFTING CAP. (LBS)	ANGLE	LIFTING CAP. (LBS)	ANGLE	LIFTING CAP. (LBS)	ANGLE	LIFTING CAP. (LBS)	ANGLE	LIFTING CAP. (LBS)	ANGLE	LIFTING CAP. (LBS)	ANGLE	LIFTING CAP. (LBS)	ANGLE	LIFTING CAP. (LBS)	LOAD RADIUS (FT)
LENGTH	39.3 FT		53 FT		66 FT		79 FT		92 FT		105 FT		118 FT		131 FT		
6	74°	130000															6
8	70°	65030															8
10	67°	40730	74°	42340	77°	43260											10
12	64°	28480	71°	29860	76°	30650	78°	31170									12
15	59°	18390	68°	19600	73°	20270	76°	20720	79°	21040							15
20	50°	9930	62°	11010	68°	11590	72°	11980	75°	12250	78°	12450					20
25	40°	5450	55°	6480	63°	7020	69°	7380	72°	7630	75°	7810	77°	7950			25
30	26°	2620	49°	3670	58°	4200	65°	4540	69°	4780	72°	4950	75°	5080	77°	5190	30
35			41°	1760	53°	2280	61°	2610	66°	2840	69°	3010	73°	3130	75°	3230	35
40					47°	890	56°	1220	62°	1440	66°	1600	70°	1720	73°	1820	40
45																	45
50																	50
55																	55
60																	60
65																	65
70																	70
75																	75
80																	80
85																	85
90																	90
95																	95
100																	100
105																	105
110																	110
115																	115
120																	120
125																	125
130																	130
DEDUCTIONS FOR MAIN BOOM CAPACITIES	0°	1500	0°	0	0°	0	0°	0	0°	0	0°	0	0°	0	0°	0	
		1570		1140		920		770		660		580		520		460	STOWED
		3510		3240		3100		3010		2940		2890		2850		2820	RET
		3910		3530		3340		3200		3110		3040		2980		2940	EXT
	2620		2420		2320		2250		2200		2170		2140		2120	FIXED	

CODE 63

MAIN BOOM

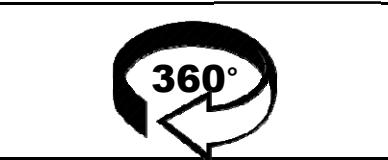
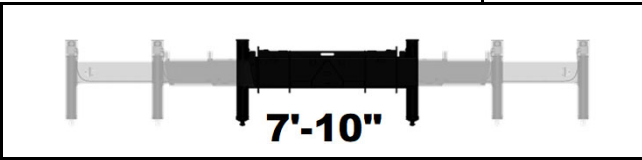
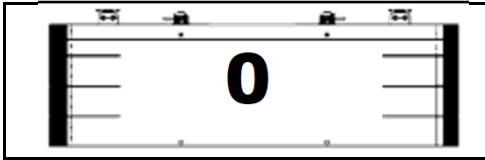

LOAD RADIUS (FT)	ANGLE	LIFTING CAP. (LBS)	ANGLE	LIFTING CAP. (LBS)	ANGLE	LIFTING CAP. (LBS)	ANGLE	LIFTING CAP. (LBS)	ANGLE	LIFTING CAP. (LBS)	ANGLE	LIFTING CAP. (LBS)	ANGLE	LIFTING CAP. (LBS)	ANGLE	LIFTING CAP. (LBS)	LOAD RADIUS (FT)
LENGTH	39.3 FT		53 FT		66 FT		79 FT		92 FT		105 FT		118 FT		131 FT		
6	74°	130000															6
8	70°	61220															8
10	67°	38170	74°	39790	77°	40710											10
12	64°	26560	71°	27940	76°	28730	78°	29250									12
15	59°	17000	68°	18200	73°	18870	76°	19320	79°	19640							15
20	50°	8970	62°	10040	68°	10630	72°	11010	75°	11290	78°	11490					20
25	40°	4710	55°	5740	63°	6290	69°	6640	72°	6890	75°	7080	77°	7220			25
30	26°	2030	49°	3080	58°	3610	65°	3950	69°	4180	72°	4360	75°	4490	77°	4590	30
35			41°	1260	53°	1780	61°	2120	66°	2340	69°	2510	73°	2630	75°	2730	35
40							56°	790	62°	1010	66°	1170	70°	1290	73°	1390	40
45																	45
50																	50
55																	55
60																	60
65																	65
70																	70
75																	75
80																	80
85																	85
90																	90
95																	95
100																	100
105																	105
110																	110
115																	115
120																	120
125																	125
130																	130
DEDUCTIONS FOR MAIN BOOM CAPACITIES	0°	950	0°	0	0°	0	0°	0	0°	0	0°	0	0°	0	0°	0	
		1570		1140		920		770		660		580		520		460	STOWED
		3510		3240		3100		3010		2940		2890		2850		2820	RET
		3910		3530		3340		3200		3110		3040		2980		2940	EXT
	2620		2420		2320		2250		2200		2170		2140		2120	FIXED	

**CODES 64, 73, 82, 91,
100, 109
RETRACTED 30' JIB**

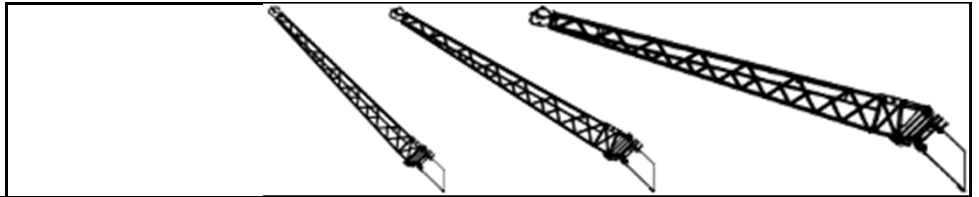

10,000

24'-6"

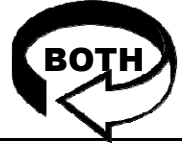

LOAD RADIUS (FT)	0° OFFSET				15° OFFSET			30° OFFSET			LOAD RADIUS (FT)
	BOOM ANGLE (DEG)	CODE 91	CODE 64	BOOM ANGLE (DEG)	CODE 100	CODE 73	BOOM ANGLE (DEG)	CODE 109	CODE 82		
		OVER REAR (LBS)	FULL 360° (LBS)		OVER REAR (LBS)	FULL 360° (LBS)		OVER REAR (LBS)	FULL 360° (LBS)		
6										6	
8										8	
10										10	
12										12	
15										15	
20										20	
25										25	
30										30	
35	79°	9000	9000							35	
40	77°	9000	9000	79°	9000	9000				40	
45	75°	9000	9000	78°	8580	8580				45	
50	74°	9000	9000	76°	8130	8130	79°	7680	7680	50	
55	72°	8560	8560	74°	7680	7680	77°	7270	7270	55	
60	70°	8100	8100	73°	7260	7260	75°	6890	6890	60	
65	68°	7680	7680	71°	6870	6870	73°	6540	6540	65	
70	66°	7240	7240	69°	6510	6510	71°	6210	6210	70	
75	64°	6840	6840	67°	6180	6180	69°	5910	5910	75	
80	62°	6260	6260	65°	5850	5850	67°	5630	5630	80	
85	60°	5730	5730	63°	5550	5550	65°	5360	5360	85	
90	58°	5220	5220	61°	5090	5090	63°	5100	5100	90	
95	55°	4750	4750	58°	4630	4630	60°	4850	4850	95	
100	53°	4320	4280	56°	4190	4190	58°	4410	4410	100	
105	50°	3900	3660	53°	3800	3800	55°	3990	3990	105	
110	48°	3520	3110	50°	3430	3430	52°	3600	3600	110	
115	45°	3170	2620	48°	3080	2920	49°	3230	3150	115	
120	42°	2830	2170	45°	2760	2440	46°	2880	2630	120	
125	39°	2520	1750	42°	2450	2000	43°	2550	2160	125	
130	36°	2240	1380	38°	2160	1590	39°	2240	1730	130	
135	32°	1970	1030	34°	1880	1220	35°	1950	1320	135	
140	28°	1720		30°	1620	860	30°	1670	930	140	
145										145	
150										150	

**CODES 65, 74, 83, 92,
101, 110**
RETRACTED 30' JIB

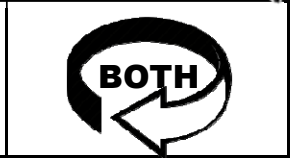
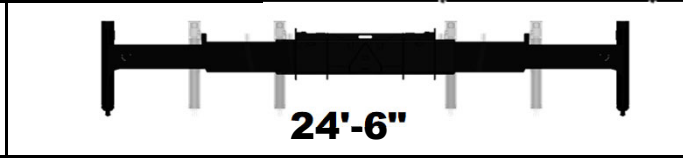
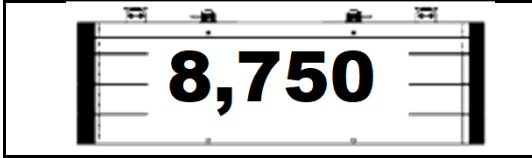
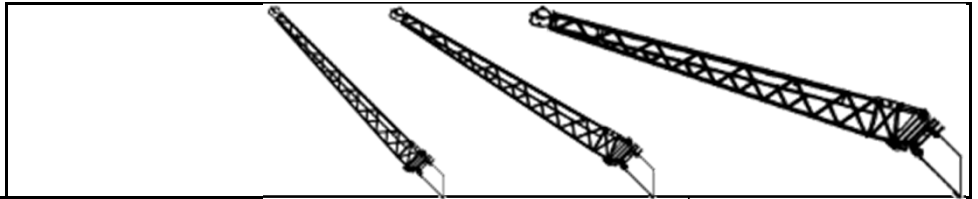

LOAD RADIUS (FT)	0° OFFSET				15° OFFSET			30° OFFSET			LOAD RADIUS (FT)
	BOOM ANGLE (DEG)	CODE 92	CODE 65	BOOM ANGLE (DEG)	CODE 101	CODE 74	BOOM ANGLE (DEG)	CODE 110	CODE 83		
		OVER REAR (LBS)	FULL 360° (LBS)		OVER REAR (LBS)	FULL 360° (LBS)		OVER REAR (LBS)	FULL 360° (LBS)		
6										6	
8										8	
10										10	
12										12	
15										15	
20										20	
25										25	
30										30	
35	79°	9000	9000							35	
40	77°	9000	9000	79°	9000	9000				40	
45	75°	9000	9000	78°	8580	8580				45	
50	74°	9000	9000	76°	8130	8130	79°	7680	7680	50	
55	72°	8560	8560	74°	7680	7680	77°	7270	7270	55	
60	70°	8100	8100	73°	7260	7260	75°	6890	6890	60	
65	68°	7680	7680	71°	6870	6870	73°	6540	6540	65	
70	66°	7240	7240	69°	6510	6510	71°	6210	6210	70	
75	64°	6840	6840	67°	6180	6180	69°	5910	5910	75	
80	62°	6260	6260	65°	5850	5850	67°	5630	5630	80	
85	60°	5730	5730	63°	5550	5550	65°	5360	5360	85	
90	58°	5220	5220	61°	5090	5090	63°	5100	5100	90	
95	55°	4750	4660	58°	4630	4630	60°	4850	4850	95	
100	53°	4320	3990	56°	4190	4190	58°	4410	4410	100	
105	50°	3900	3390	53°	3800	3770	55°	3990	3990	105	
110	48°	3520	2860	50°	3430	3200	52°	3600	3450	110	
115	45°	3170	2370	48°	3080	2680	49°	3230	2900	115	
120	42°	2830	1930	45°	2760	2210	46°	2880	2400	120	
125	39°	2520	1530	42°	2450	1780	43°	2550	1940	125	
130	36°	2240	1170	38°	2160	1380	39°	2240	1510	130	
135	32°	1960		34°	1880	1010	35°	1950	1120	135	
140	28°	1610		30°	1620		30°	1670		140	
145										145	
150										150	

**CODES 66, 75, 84, 93,
102, 111**
RETRACTED 30' JIB

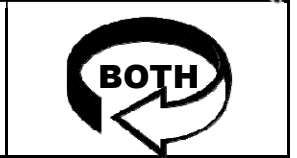
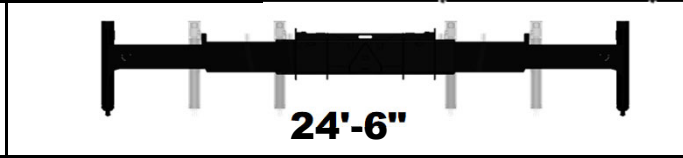
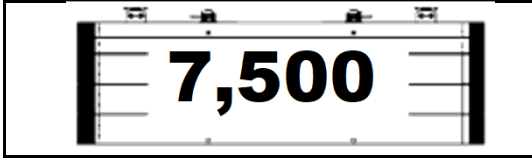
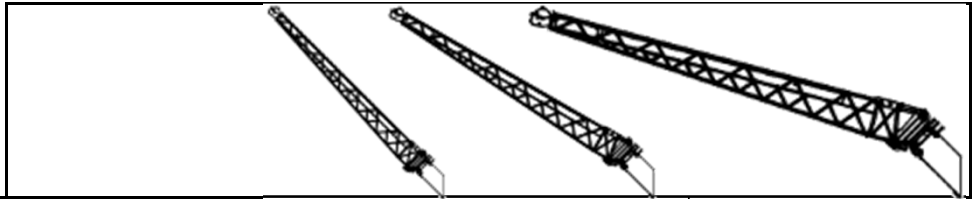

LOAD RADIUS (FT)	0° OFFSET				15° OFFSET			30° OFFSET			LOAD RADIUS (FT)
	BOOM ANGLE (DEG)	CODE 93	CODE 66	BOOM ANGLE (DEG)	CODE 102	CODE 75	BOOM ANGLE (DEG)	CODE 111	CODE 84		
		OVER REAR (LBS)	FULL 360° (LBS)		OVER REAR (LBS)	FULL 360° (LBS)		OVER REAR (LBS)	FULL 360° (LBS)		
6										6	
8										8	
10										10	
12										12	
15										15	
20										20	
25										25	
30										30	
35	79°	9000	9000							35	
40	77°	9000	9000	79°	9000	9000				40	
45	75°	9000	9000	78°	8580	8580				45	
50	74°	9000	9000	76°	8130	8130	79°	7680	7680	50	
55	72°	8560	8560	74°	7680	7680	77°	7270	7270	55	
60	70°	8100	8100	73°	7260	7260	75°	6890	6890	60	
65	68°	7680	7680	71°	6870	6870	73°	6540	6540	65	
70	66°	7240	7240	69°	6510	6510	71°	6210	6210	70	
75	64°	6840	6840	67°	6180	6180	69°	5910	5910	75	
80	62°	6260	6260	65°	5850	5850	67°	5630	5630	80	
85	60°	5730	5730	63°	5550	5550	65°	5360	5360	85	
90	58°	5220	5090	61°	5090	5090	63°	5100	5100	90	
95	55°	4750	4360	58°	4630	4630	60°	4850	4850	95	
100	53°	4320	3710	56°	4190	4120	58°	4410	4410	100	
105	50°	3900	3130	53°	3800	3500	55°	3990	3790	105	
110	48°	3520	2600	50°	3430	2940	52°	3600	3200	110	
115	45°	3170	2130	48°	3080	2440	49°	3230	2660	115	
120	42°	2830	1700	45°	2760	1980	46°	2880	2170	120	
125	39°	2520	1310	42°	2450	1560	43°	2550	1720	125	
130	36°	2150	950	38°	2160	1170	39°	2240	1300	130	
135	32°	1780		34°	1880		35°	1950	910	135	
140	28°	1440		30°	1590		30°	1660		140	
145										145	
150										150	

**CODES 67, 76, 85, 94,
103, 112**
RETRACTED 30' JIB

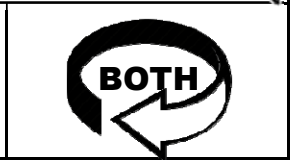
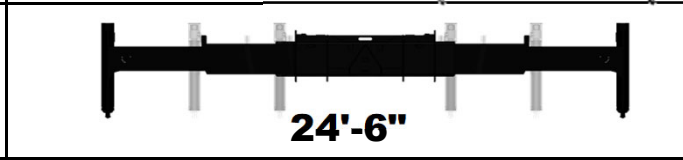
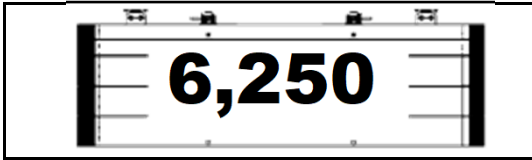
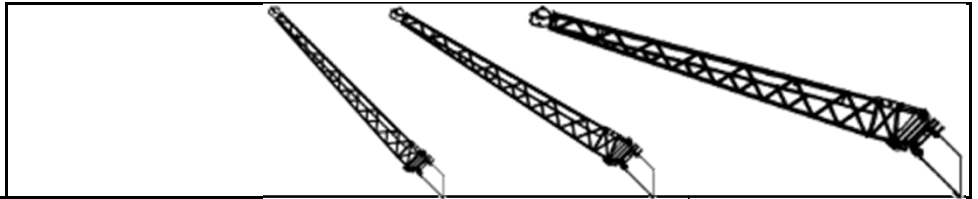

LOAD RADIUS (FT)	0° OFFSET			15° OFFSET			30° OFFSET			LOAD RADIUS (FT)
	BOOM ANGLE (DEG)	CODE 94	CODE 67	BOOM ANGLE (DEG)	CODE 103	CODE 76	BOOM ANGLE (DEG)	CODE 112	CODE 85	
		OVER REAR (LBS)	FULL 360° (LBS)		OVER REAR (LBS)	FULL 360° (LBS)		OVER REAR (LBS)	FULL 360° (LBS)	
6										6
8										8
10										10
12										12
15										15
20										20
25										25
30										30
35	79°	9000	9000							35
40	77°	9000	9000	79°	9000	9000				40
45	75°	9000	9000	78°	8580	8580				45
50	74°	9000	9000	76°	8130	8130	79°	7680	7680	50
55	72°	8560	8560	74°	7680	7680	77°	7270	7270	55
60	70°	8100	8100	73°	7260	7260	75°	6890	6890	60
65	68°	7680	7680	71°	6870	6870	73°	6540	6540	65
70	66°	7240	7240	69°	6510	6510	71°	6210	6210	70
75	64°	6840	6840	67°	6180	6180	69°	5910	5910	75
80	62°	6260	6260	65°	5850	5850	67°	5630	5630	80
85	60°	5730	5590	63°	5550	5550	65°	5360	5360	85
90	58°	5220	4770	61°	5090	5090	63°	5100	5100	90
95	55°	4750	4060	58°	4630	4510	60°	4850	4850	95
100	53°	4320	3420	56°	4190	3830	58°	4410	4160	100
105	50°	3900	2860	53°	3800	3230	55°	3990	3520	105
110	48°	3520	2350	50°	3430	2690	52°	3600	2940	110
115	45°	3170	1890	48°	3080	2190	49°	3230	2420	115
120	42°	2790	1470	45°	2760	1750	46°	2880	1940	120
125	39°	2360	1090	42°	2450	1330	43°	2550	1500	125
130	36°	1960		38°	2160	960	39°	2240	1090	130
135	32°	1600		34°	1780		35°	1880		135
140	28°	1260		30°	1410		30°	1480		140
145										145
150										150

**CODES 68, 77, 86, 95,
104, 113**
RETRACTED 30' JIB

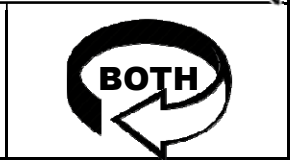
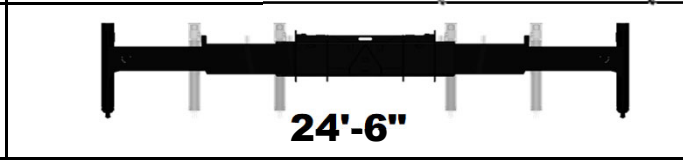
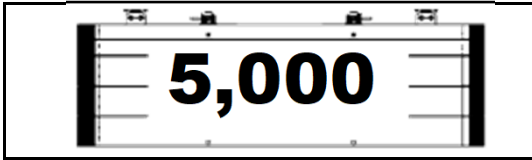
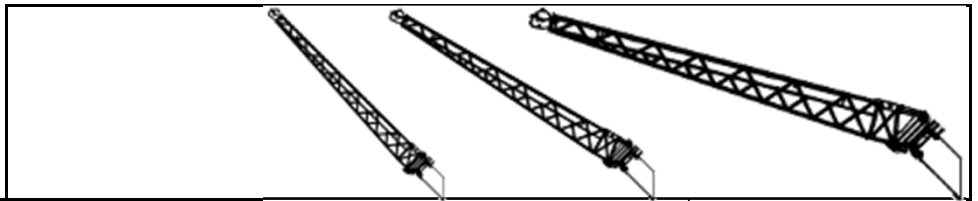

LOAD RADIUS (FT)	0° OFFSET			15° OFFSET			30° OFFSET			LOAD RADIUS (FT)
	BOOM ANGLE (DEG)	CODE 95	CODE 68	BOOM ANGLE (DEG)	CODE 104	CODE 77	BOOM ANGLE (DEG)	CODE 113	CODE 86	
		OVER REAR (LBS)	FULL 360° (LBS)		OVER REAR (LBS)	FULL 360° (LBS)		OVER REAR (LBS)	FULL 360° (LBS)	
6										6
8										8
10										10
12										12
15										15
20										20
25										25
30										30
35	79°	9000	9000							35
40	77°	9000	9000	79°	9000	9000				40
45	75°	9000	9000	78°	8580	8580				45
50	74°	9000	9000	76°	8130	8130	79°	7680	7680	50
55	72°	8560	8560	74°	7680	7680	77°	7270	7270	55
60	70°	8100	8100	73°	7260	7260	75°	6890	6890	60
65	68°	7680	7680	71°	6870	6870	73°	6540	6540	65
70	66°	7240	7240	69°	6510	6510	71°	6210	6210	70
75	64°	6840	6840	67°	6180	6180	69°	5910	5910	75
80	62°	6260	6150	65°	5850	5850	67°	5630	5630	80
85	60°	5730	5240	63°	5550	5550	65°	5360	5360	85
90	58°	5220	4450	61°	5090	4950	63°	5100	5100	90
95	55°	4750	3750	58°	4630	4200	60°	4850	4570	95
100	53°	4320	3140	56°	4190	3550	58°	4410	3870	100
105	50°	3900	2590	53°	3800	2960	55°	3990	3250	105
110	48°	3520	2090	50°	3430	2430	52°	3600	2690	110
115	45°	3040	1650	48°	3080	1950	49°	3230	2170	115
120	42°	2580	1240	45°	2760	1510	46°	2880	1710	120
125	39°	2160	870	42°	2400	1110	43°	2550	1280	125
130	36°	1770		38°	1980		39°	2110	880	130
135	32°	1420		34°	1600		35°	1700		135
140	28°	1090		30°	1240		30°	1310		140
145										145
150										150

**CODES 69, 78, 87, 96,
105, 114
RETRACTED 30' JIB**

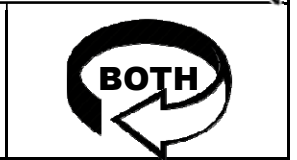
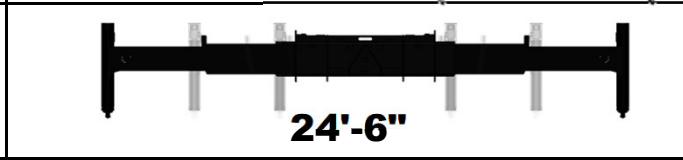
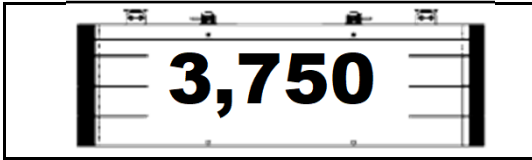
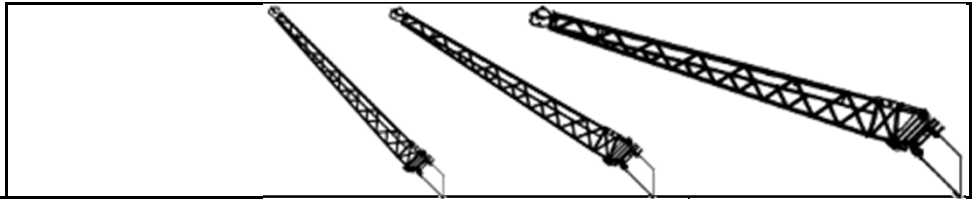

LOAD RADIUS (FT)	0° OFFSET			15° OFFSET			30° OFFSET			LOAD RADIUS (FT)
	BOOM ANGLE (DEG)	CODE 96	CODE 69	BOOM ANGLE (DEG)	CODE 105	CODE 78	BOOM ANGLE (DEG)	CODE 114	CODE 87	
		OVER REAR (LBS)	FULL 360° (LBS)		OVER REAR (LBS)	FULL 360° (LBS)		OVER REAR (LBS)	FULL 360° (LBS)	
6										6
8										8
10										10
12										12
15										15
20										20
25										25
30										30
35	79°	9000	9000							35
40	77°	9000	9000	79°	9000	9000				40
45	75°	9000	9000	78°	8580	8580				45
50	74°	9000	9000	76°	8130	8130	79°	7680	7680	50
55	72°	8560	8560	74°	7680	7680	77°	7270	7270	55
60	70°	8100	8100	73°	7260	7260	75°	6890	6890	60
65	68°	7680	7680	71°	6870	6870	73°	6540	6540	65
70	66°	7240	7240	69°	6510	6510	71°	6210	6210	70
75	64°	6840	6810	67°	6180	6180	69°	5910	5910	75
80	62°	6260	5780	65°	5850	5850	67°	5630	5630	80
85	60°	5730	4900	63°	5550	5440	65°	5360	5360	85
90	58°	5220	4130	61°	5090	4620	63°	5100	5030	90
95	55°	4750	3450	58°	4630	3900	60°	4850	4270	95
100	53°	4320	2850	56°	4190	3260	58°	4410	3590	100
105	50°	3870	2320	53°	3800	2690	55°	3990	2980	105
110	48°	3320	1840	50°	3430	2170	52°	3600	2430	110
115	45°	2830	1400	48°	3080	1710	49°	3230	1930	115
120	42°	2380	1010	45°	2640	1280	46°	2830	1470	120
125	39°	1960		42°	2200	890	43°	2360	1050	125
130	36°	1590		38°	1800		39°	1930		130
135	32°	1240		34°	1420		35°	1520		135
140	28°	910		30°	1070		30°	1130		140
145										145
150										150

**CODES 70, 79, 88, 97,
106, 115
RETRACTED 30' JIB**

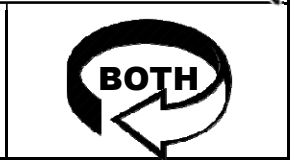
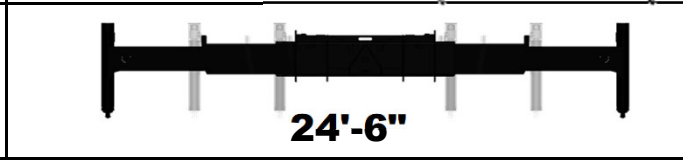
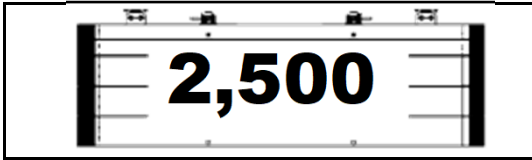
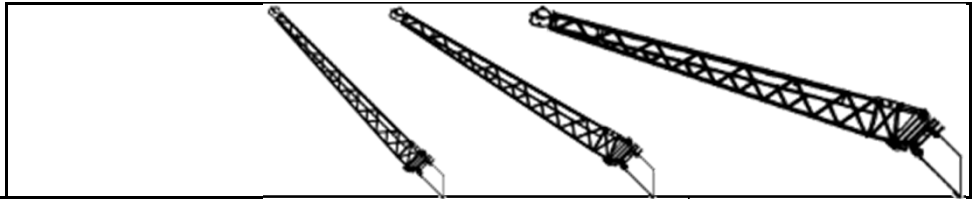

LOAD RADIUS (FT)	0° OFFSET			15° OFFSET			30° OFFSET			LOAD RADIUS (FT)
	BOOM ANGLE (DEG)	CODE 97	CODE 70	BOOM ANGLE (DEG)	CODE 106	CODE 79	BOOM ANGLE (DEG)	CODE 115	CODE 88	
		OVER REAR (LBS)	FULL 360° (LBS)		OVER REAR (LBS)	FULL 360° (LBS)		OVER REAR (LBS)	FULL 360° (LBS)	
6										6
8										8
10										10
12										12
15										15
20										20
25										25
30										30
35	79°	9000	9000							35
40	77°	9000	9000	79°	9000	9000				40
45	75°	9000	9000	78°	8580	8580				45
50	74°	9000	9000	76°	8130	8130	79°	7680	7680	50
55	72°	8560	8560	74°	7680	7680	77°	7270	7270	55
60	70°	8100	8100	73°	7260	7260	75°	6890	6890	60
65	68°	7680	7680	71°	6870	6870	73°	6540	6540	65
70	66°	7240	7240	69°	6510	6510	71°	6210	6210	70
75	64°	6840	6410	67°	6180	6180	69°	5910	5910	75
80	62°	6260	5410	65°	5850	5850	67°	5630	5630	80
85	60°	5730	4560	63°	5550	5100	65°	5360	5360	85
90	58°	5220	3810	61°	5090	4300	63°	5100	4710	90
95	55°	4750	3150	58°	4630	3600	60°	4850	3970	95
100	53°	4230	2570	56°	4190	2980	58°	4410	3300	100
105	50°	3630	2050	53°	3800	2420	55°	3990	2710	105
110	48°	3100	1580	50°	3430	1920	52°	3600	2170	110
115	45°	2610	1160	48°	2910	1460	49°	3130	1690	115
120	42°	2170		45°	2440	1050	46°	2630	1240	120
125	39°	1770		42°	2010		43°	2170		125
130	36°	1400		38°	1610		39°	1740		130
135	32°	1060		34°	1240		35°	1340		135
140				30°	890		30°	960		140
145										145
150										150

**CODES 71, 80, 89, 98,
107, 116
RETRACTED 30' JIB**

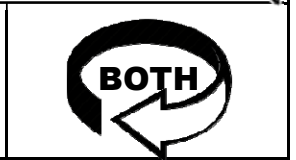
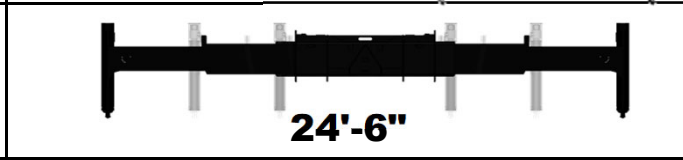
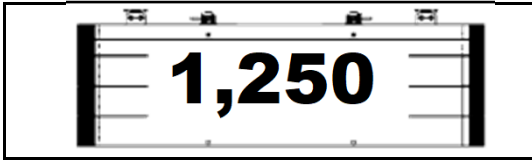
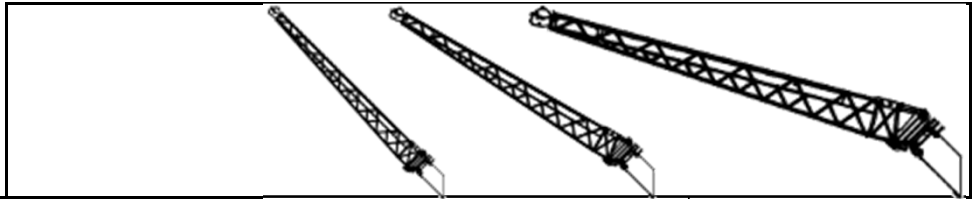

LOAD RADIUS (FT)	0° OFFSET			15° OFFSET			30° OFFSET			LOAD RADIUS (FT)
	BOOM ANGLE (DEG)	CODE 98	CODE 71	BOOM ANGLE (DEG)	CODE 107	CODE 80	BOOM ANGLE (DEG)	CODE 116	CODE 89	
		OVER REAR (LBS)	FULL 360° (LBS)		OVER REAR (LBS)	FULL 360° (LBS)		OVER REAR (LBS)	FULL 360° (LBS)	
6										6
8										8
10										10
12										12
15										15
20										20
25										25
30										30
35	79°	9000	9000							35
40	77°	9000	9000	79°	9000	9000				40
45	75°	9000	9000	78°	8580	8580				45
50	74°	9000	9000	76°	8130	8130	79°	7680	7680	50
55	72°	8560	8560	74°	7680	7680	77°	7270	7270	55
60	70°	8100	8100	73°	7260	7260	75°	6890	6890	60
65	68°	7680	7680	71°	6870	6870	73°	6540	6540	65
70	66°	7240	7140	69°	6510	6510	71°	6210	6210	70
75	64°	6840	6010	67°	6180	6180	69°	5910	5910	75
80	62°	6260	5050	65°	5850	5640	67°	5630	5630	80
85	60°	5730	4210	63°	5550	4760	65°	5360	5210	85
90	58°	5220	3490	61°	5090	3980	63°	5100	4390	90
95	55°	4630	2850	58°	4630	3300	60°	4850	3660	95
100	53°	3980	2280	56°	4190	2690	58°	4410	3020	100
105	50°	3400	1780	53°	3760	2150	55°	3990	2440	105
110	48°	2870	1330	50°	3200	1660	52°	3450	1920	110
115	45°	2400	920	48°	2700	1220	49°	2910	1450	115
120	42°	1970		45°	2230		46°	2420	1010	120
125	39°	1570		42°	1810		43°	1970		125
130	36°	1210		38°	1420		39°	1550		130
135	32°	870		34°	1060		35°	1160		135
140										140
145										145
150										150

**CODES 72, 81, 90, 99,
108, 117**
RETRACTED 30' JIB

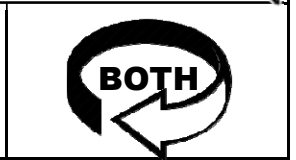
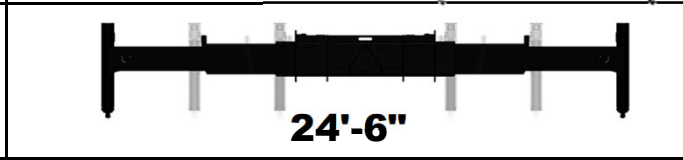
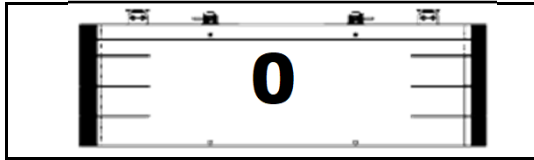
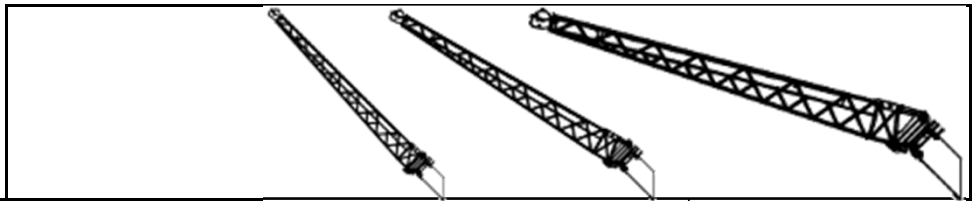

LOAD RADIUS (FT)	0° OFFSET			15° OFFSET			30° OFFSET			LOAD RADIUS (FT)
	BOOM ANGLE (DEG)	CODE 99	CODE 72	BOOM ANGLE (DEG)	CODE 108	CODE 81	BOOM ANGLE (DEG)	CODE 117	CODE 90	
		OVER REAR (LBS)	FULL 360° (LBS)		OVER REAR (LBS)	FULL 360° (LBS)		OVER REAR (LBS)	FULL 360° (LBS)	
6										6
8										8
10										10
12										12
15										15
20										20
25										25
30										30
35	79°	9000	9000							35
40	77°	9000	9000	79°	9000	9000				40
45	75°	9000	9000	78°	8580	8580				45
50	74°	9000	9000	76°	8130	8130	79°	7680	7680	50
55	72°	8560	8560	74°	7680	7680	77°	7270	7270	55
60	70°	8100	8100	73°	7260	7260	75°	6890	6890	60
65	68°	7680	7680	71°	6870	6870	73°	6540	6540	65
70	66°	7240	6710	69°	6510	6510	71°	6210	6210	70
75	64°	6840	5610	67°	6180	6180	69°	5910	5910	75
80	62°	6260	4680	65°	5850	5280	67°	5630	5630	80
85	60°	5730	3870	63°	5550	4410	65°	5360	4870	85
90	58°	5080	3170	61°	5090	3660	63°	5100	4070	90
95	55°	4360	2550	58°	4630	3000	60°	4850	3360	95
100	53°	3730	2000	56°	4130	2410	58°	4410	2730	100
105	50°	3160	1510	53°	3520	1880	55°	3800	2170	105
110	48°	2650	1070	50°	2980	1410	52°	3230	1660	110
115	45°	2180		48°	2480	980	49°	2700	1200	115
120	42°	1760		45°	2030		46°	2220		120
125	39°	1370		42°	1610		43°	1770		125
130	36°	1020		38°	1230		39°	1360		130
135				34°	880		35°	980		135
140										140
145										145
150										150

**CODES 118, 127, 136,
145, 154, 163**
EXTENDED 50' JIB

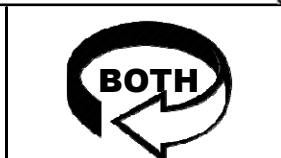
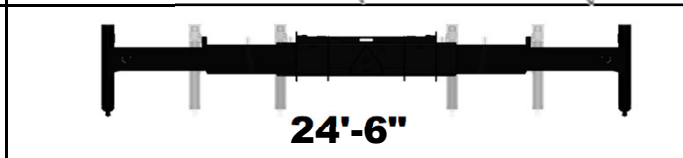
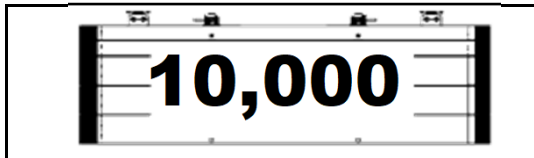
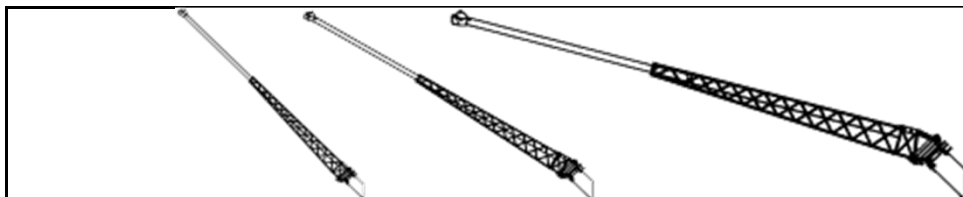

LOAD RADIUS (FT)	0° OFFSET			15° OFFSET			30° OFFSET			LOAD RADIUS (FT)
	BOOM ANGLE (DEG)	CODE 145 OVER REAR (LBS)	CODE 118 FULL 360° (LBS)	BOOM ANGLE (DEG)	CODE 154 OVER REAR (LBS)	CODE 127 FULL 360° (LBS)	BOOM ANGLE (DEG)	CODE 163 OVER REAR (LBS)	CODE 136 FULL 360° (LBS)	
25										25
30										30
35										35
40	79°	7600	7600							40
45	76°	7200	7200							45
50	75°	6900	6900	79°	6370	6370				50
55	73°	6500	6500	78°	6040	6040				55
60	72°	6200	6200	76°	5750	5750	79°	5340	5340	60
65	70°	5900	5900	75°	5460	5460	78°	5080	5080	65
70	69°	5600	5600	73°	5190	5190	76°	4840	4840	70
75	67°	5300	5300	71°	4940	4940	74°	4620	4620	75
80	66°	5000	5000	70°	4700	4700	72°	4410	4410	80
85	64°	4800	4800	68°	4470	4470	70°	4210	4210	85
90	63°	4500	4500	66°	4260	4260	69°	4020	4020	90
95	61°	4300	4300	64°	4060	4060	67°	3850	3850	95
100	59°	4100	4100	62°	3870	3870	65°	3680	3680	100
105	57°	3900	3900	60°	3690	3690	63°	3530	3530	105
110	54°	3600	3600	58°	3530	3530	61°	3390	3390	110
115	52°	3300	3300	56°	3370	3370	58°	3250	3250	115
120	49°	3000	3000	53°	3220	3220	56°	3130	3130	120
125	47°	2700	2600	51°	2980	2980	53°	3000	3000	125
130	44°	2400	2220	48°	2700	2610	50°	2890	2890	130
135	42°	2200	1870	45°	2440	2230	47°	2610	2500	135
140	39°	2000	1540	42°	2190	1870	44°	2340	2100	140
145	36°	1700	1240	39°	1950	1530	41°	2070	1730	145
150	33°	1500	960	36°	1720	1220	37°	1820	1380	150
155	30°	1300		32°	1500	930	32°	1580	1050	155
160										160
165										165
170										170
175										175
180										180

**CODES 119, 128, 137,
146, 155, 164**
EXTENDED 50' JIB

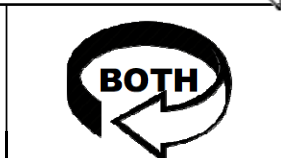
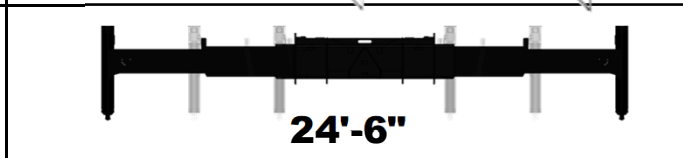
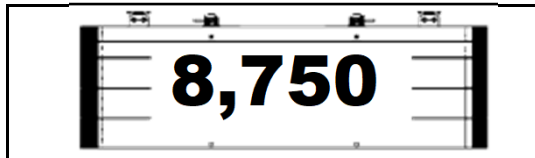
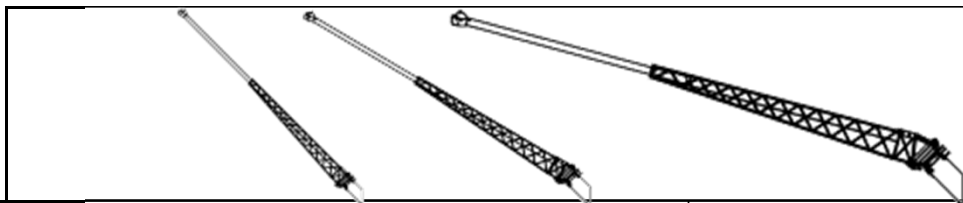

LOAD RADIUS (FT)	0° OFFSET			15° OFFSET			30° OFFSET			LOAD RADIUS (FT)
	BOOM ANGLE (DEG)	CODE 146 OVER REAR (LBS)	CODE 119 FULL 360° (LBS)	BOOM ANGLE (DEG)	CODE 155 OVER REAR (LBS)	CODE 128 FULL 360° (LBS)	BOOM ANGLE (DEG)	CODE 164 OVER REAR (LBS)	CODE 137 FULL 360° (LBS)	
25										25
30										30
35										35
40	79°	7600	7600							40
45	76°	7200	7200							45
50	75°	6900	6900	79°	6370	6370				50
55	73°	6500	6500	78°	6040	6040				55
60	72°	6200	6200	76°	5750	5750	79°	5340	5340	60
65	70°	5900	5900	75°	5460	5460	78°	5080	5080	65
70	69°	5600	5600	73°	5190	5190	76°	4840	4840	70
75	67°	5300	5300	71°	4940	4940	74°	4620	4620	75
80	66°	5000	5000	70°	4700	4700	72°	4410	4410	80
85	64°	4800	4800	68°	4470	4470	70°	4210	4210	85
90	63°	4500	4500	66°	4260	4260	69°	4020	4020	90
95	61°	4300	4300	64°	4060	4060	67°	3850	3850	95
100	59°	4100	4100	62°	3870	3870	65°	3680	3680	100
105	57°	3900	3900	60°	3690	3690	63°	3530	3530	105
110	54°	3600	3600	58°	3530	3530	61°	3390	3390	110
115	52°	3300	3230	56°	3370	3370	58°	3250	3250	115
120	49°	3000	2780	53°	3220	3220	56°	3130	3130	120
125	47°	2700	2380	51°	2980	2810	53°	3000	3000	125
130	44°	2400	2000	48°	2700	2400	50°	2890	2710	130
135	42°	2200	1660	45°	2440	2020	47°	2610	2290	135
140	39°	2000	1350	42°	2190	1670	44°	2340	1910	140
145	36°	1700	1050	39°	1950	1350	41°	2070	1540	145
150	33°	1500	780	36°	1720	1040	37°	1820	1200	150
155	30°	1300		32°	1500		32°	1580	870	155
160										160
165										165
170										170
175										175
180										180

**CODES 120, 129, 138,
147, 156, 165**
EXTENDED 50' JIB

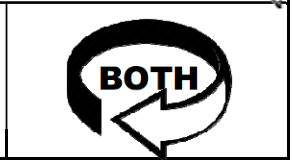
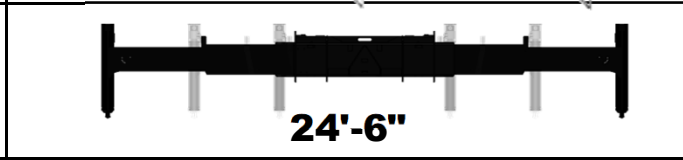
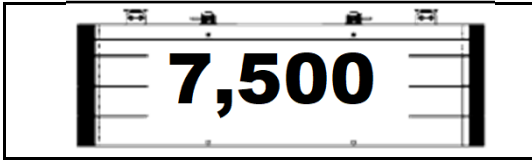
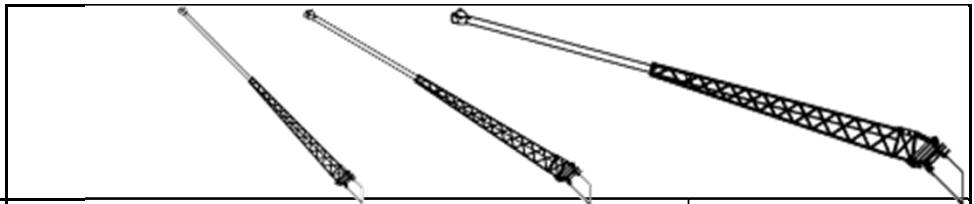

LOAD RADIUS (FT)	0° OFFSET			15° OFFSET			30° OFFSET			LOAD RADIUS (FT)
	BOOM ANGLE (DEG)	CODE 147	CODE 120	BOOM ANGLE (DEG)	CODE 156	CODE 129	BOOM ANGLE (DEG)	CODE 165	CODE 138	
		OVER REAR (LBS)	FULL 360° (LBS)		OVER REAR (LBS)	FULL 360° (LBS)		OVER REAR (LBS)	FULL 360° (LBS)	
25										25
30										30
35										35
40	79°	7600	7600							40
45	76°	7200	7200							45
50	75°	6900	6900	79°	6370	6370				50
55	73°	6500	6500	78°	6040	6040				55
60	72°	6200	6200	76°	5750	5750	79°	5340	5340	60
65	70°	5900	5900	75°	5460	5460	78°	5080	5080	65
70	69°	5600	5600	73°	5190	5190	76°	4840	4840	70
75	67°	5300	5300	71°	4940	4940	74°	4620	4620	75
80	66°	5000	5000	70°	4700	4700	72°	4410	4410	80
85	64°	4800	4800	68°	4470	4470	70°	4210	4210	85
90	63°	4500	4500	66°	4260	4260	69°	4020	4020	90
95	61°	4300	4300	64°	4060	4060	67°	3850	3850	95
100	59°	4100	4100	62°	3870	3870	65°	3680	3680	100
105	57°	3900	3900	60°	3690	3690	63°	3530	3530	105
110	54°	3600	3460	58°	3530	3530	61°	3390	3390	110
115	52°	3300	2980	56°	3370	3370	58°	3250	3250	115
120	49°	3000	2550	53°	3220	3030	56°	3130	3130	120
125	47°	2700	2150	51°	2980	2590	53°	3000	2930	125
130	44°	2400	1790	48°	2700	2190	50°	2890	2500	130
135	42°	2200	1460	45°	2440	1820	47°	2610	2090	135
140	39°	2000	1150	42°	2190	1480	44°	2340	1710	140
145	36°	1700	870	39°	1950	1160	41°	2070	1360	145
150	33°	1500		36°	1720	860	37°	1820	1020	150
155	30°	1300		32°	1500		32°	1580		155
160										160
165										165
170										170
175										175
180										180

**CODES 121, 130, 139,
148, 157, 166**
EXTENDED 50' JIB

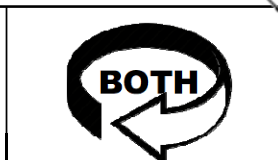
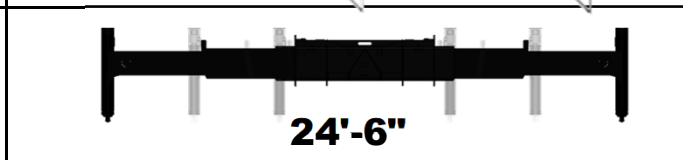
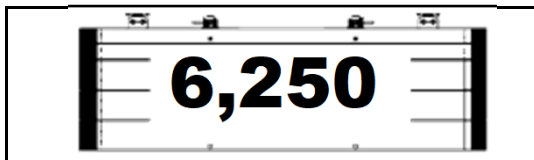
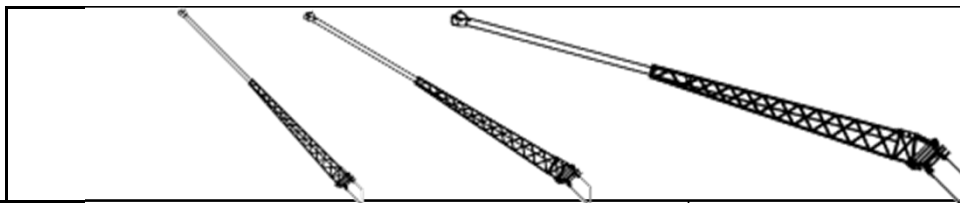

LOAD RADIUS (FT)	0° OFFSET			15° OFFSET			30° OFFSET			LOAD RADIUS (FT)
	BOOM ANGLE (DEG)	CODE 148	CODE 121	BOOM ANGLE (DEG)	CODE 157	CODE 130	BOOM ANGLE (DEG)	CODE 166	CODE 139	
		OVER REAR (LBS)	FULL 360° (LBS)		OVER REAR (LBS)	FULL 360° (LBS)		OVER REAR (LBS)	FULL 360° (LBS)	
25										25
30										30
35										35
40	79°	7600	7600							40
45	76°	7200	7200							45
50	75°	6900	6900	79°	6370	6370				50
55	73°	6500	6500	78°	6040	6040				55
60	72°	6200	6200	76°	5750	5750	79°	5340	5340	60
65	70°	5900	5900	75°	5460	5460	78°	5080	5080	65
70	69°	5600	5600	73°	5190	5190	76°	4840	4840	70
75	67°	5300	5300	71°	4940	4940	74°	4620	4620	75
80	66°	5000	5000	70°	4700	4700	72°	4410	4410	80
85	64°	4800	4800	68°	4470	4470	70°	4210	4210	85
90	63°	4500	4500	66°	4260	4260	69°	4020	4020	90
95	61°	4300	4300	64°	4060	4060	67°	3850	3850	95
100	59°	4100	4100	62°	3870	3870	65°	3680	3680	100
105	57°	3900	3720	60°	3690	3690	63°	3530	3530	105
110	54°	3600	3210	58°	3530	3530	61°	3390	3390	110
115	52°	3300	2740	56°	3370	3260	58°	3250	3250	115
120	49°	3000	2320	53°	3220	2790	56°	3130	3130	120
125	47°	2700	1930	51°	2980	2370	53°	3000	2710	125
130	44°	2400	1580	48°	2700	1980	50°	2890	2280	130
135	42°	2200	1260	45°	2440	1620	47°	2610	1890	135
140	39°	2000	960	42°	2190	1280	44°	2340	1520	140
145	36°	1700		39°	1950	970	41°	2070	1170	145
150	33°	1470		36°	1720		37°	1820	840	150
155	30°	1200		32°	1420		32°	1540		155
160										160
165										165
170										170
175										175
180										180

**CODES 122, 131, 140,
149, 158, 167**
EXTENDED 50' JIB

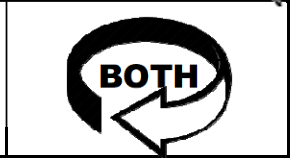
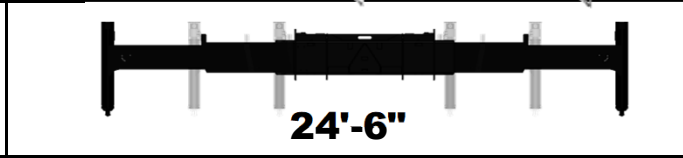
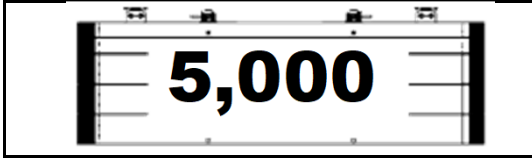
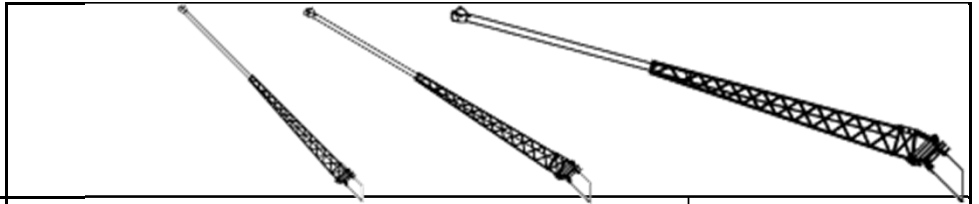

LOAD RADIUS (FT)	0° OFFSET			15° OFFSET			30° OFFSET			LOAD RADIUS (FT)
	BOOM ANGLE (DEG)	CODE 149 OVER REAR (LBS)	CODE 122 FULL 360° (LBS)	BOOM ANGLE (DEG)	CODE 158 OVER REAR (LBS)	CODE 131 FULL 360° (LBS)	BOOM ANGLE (DEG)	CODE 167 OVER REAR (LBS)	CODE 140 FULL 360° (LBS)	
25										25
30										30
35										35
40	79°	7600	7600							40
45	76°	7200	7200							45
50	75°	6900	6900	79°	6370	6370				50
55	73°	6500	6500	78°	6040	6040				55
60	72°	6200	6200	76°	5750	5750	79°	5340	5340	60
65	70°	5900	5900	75°	5460	5460	78°	5080	5080	65
70	69°	5600	5600	73°	5190	5190	76°	4840	4840	70
75	67°	5300	5300	71°	4940	4940	74°	4620	4620	75
80	66°	5000	5000	70°	4700	4700	72°	4410	4410	80
85	64°	4800	4800	68°	4470	4470	70°	4210	4210	85
90	63°	4500	4500	66°	4260	4260	69°	4020	4020	90
95	61°	4300	4300	64°	4060	4060	67°	3850	3850	95
100	59°	4100	4010	62°	3870	3870	65°	3680	3680	100
105	57°	3900	3450	60°	3690	3690	63°	3530	3530	105
110	54°	3600	2950	58°	3530	3510	61°	3390	3390	110
115	52°	3300	2500	56°	3370	3020	58°	3250	3250	115
120	49°	3000	2090	53°	3220	2560	56°	3130	2950	120
125	47°	2700	1710	51°	2980	2150	53°	3000	2490	125
130	44°	2400	1370	48°	2700	1770	50°	2890	2070	130
135	42°	2200	1050	45°	2440	1410	47°	2610	1680	135
140	39°	1900	760	42°	2190	1090	44°	2340	1320	140
145	36°	1600		39°	1880	780	41°	2070	980	145
150	33°	1310		36°	1560		37°	1720		150
155	30°	1040		32°	1260		32°	1380		155
160										160
165										165
170										170
175										175
180										180

**CODES 123, 132, 141,
150, 159, 168**
EXTENDED 50' JIB

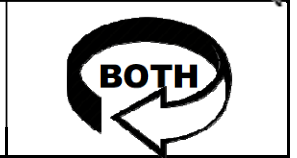
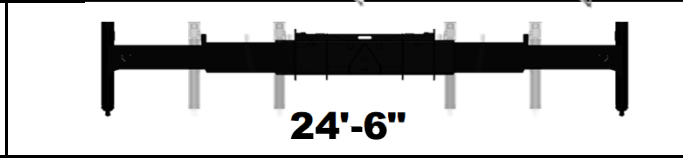
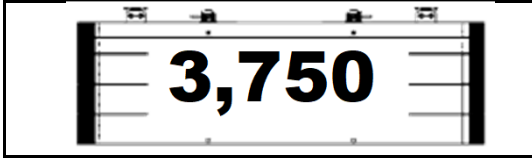
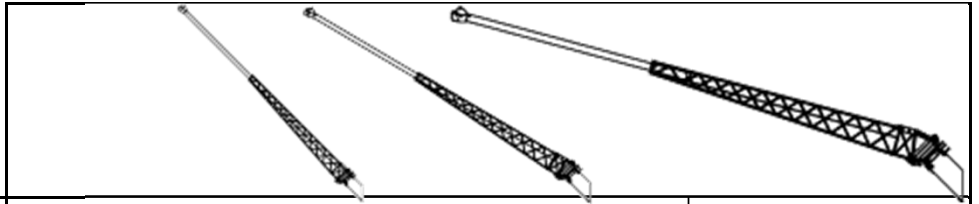

LOAD RADIUS (FT)	0° OFFSET			15° OFFSET			30° OFFSET			LOAD RADIUS (FT)
	BOOM ANGLE (DEG)	CODE 150	CODE 123	BOOM ANGLE (DEG)	CODE 159	CODE 132	BOOM ANGLE (DEG)	CODE 168	CODE 141	
		OVER REAR (LBS)	FULL 360° (LBS)		OVER REAR (LBS)	FULL 360° (LBS)		OVER REAR (LBS)	FULL 360° (LBS)	
25										25
30										30
35										35
40	79°	7600	7600							40
45	76°	7200	7200							45
50	75°	6900	6900	79°	6370	6370				50
55	73°	6500	6500	78°	6040	6040				55
60	72°	6200	6200	76°	5750	5750	79°	5340	5340	60
65	70°	5900	5900	75°	5460	5460	78°	5080	5080	65
70	69°	5600	5600	73°	5190	5190	76°	4840	4840	70
75	67°	5300	5300	71°	4940	4940	74°	4620	4620	75
80	66°	5000	5000	70°	4700	4700	72°	4410	4410	80
85	64°	4800	4800	68°	4470	4470	70°	4210	4210	85
90	63°	4500	4500	66°	4260	4260	69°	4020	4020	90
95	61°	4300	4300	64°	4060	4060	67°	3850	3850	95
100	59°	4100	3730	62°	3870	3870	65°	3680	3680	100
105	57°	3900	3190	60°	3690	3690	63°	3530	3530	105
110	54°	3600	2700	58°	3530	3260	61°	3390	3390	110
115	52°	3300	2260	56°	3370	2770	58°	3250	3200	115
120	49°	3000	1860	53°	3220	2330	56°	3130	2710	120
125	47°	2700	1490	51°	2980	1930	53°	3000	2270	125
130	44°	2400	1160	48°	2700	1550	50°	2890	1860	130
135	42°	2060	850	45°	2410	1210	47°	2610	1480	135
140	39°	1730		42°	2050	890	44°	2280	1130	140
145	36°	1430		39°	1720		41°	1910	790	145
150	33°	1150		36°	1400		37°	1560		150
155	30°	890		32°	1110		32°	1230		155
160										160
165										165
170										170
175										175
180										180

**CODES 124, 133, 142,
151, 160, 169**
EXTENDED 50' JIB

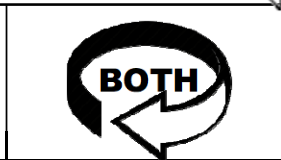
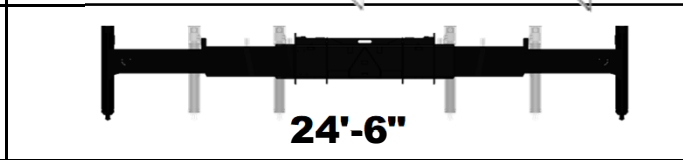
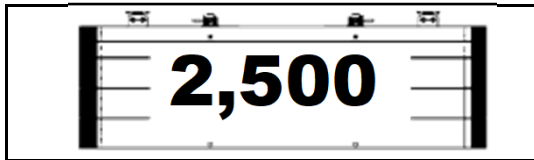
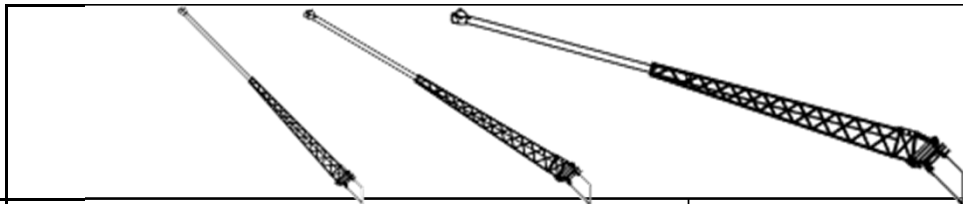

LOAD RADIUS (FT)	0° OFFSET				15° OFFSET			30° OFFSET			LOAD RADIUS (FT)
	BOOM ANGLE (DEG)	CODE 151	CODE 124	BOOM ANGLE (DEG)	CODE 160	CODE 133	BOOM ANGLE (DEG)	CODE 169	CODE 142		
		OVER REAR (LBS)	FULL 360° (LBS)		OVER REAR (LBS)	FULL 360° (LBS)		OVER REAR (LBS)	FULL 360° (LBS)		
25										25	
30										30	
35										35	
40	79°	7600	7600							40	
45	76°	7200	7200							45	
50	75°	6900	6900	79°	6370	6370				50	
55	73°	6500	6500	78°	6040	6040				55	
60	72°	6200	6200	76°	5750	5750	79°	5340	5340	60	
65	70°	5900	5900	75°	5460	5460	78°	5080	5080	65	
70	69°	5600	5600	73°	5190	5190	76°	4840	4840	70	
75	67°	5300	5300	71°	4940	4940	74°	4620	4620	75	
80	66°	5000	5000	70°	4700	4700	72°	4410	4410	80	
85	64°	4800	4800	68°	4470	4470	70°	4210	4210	85	
90	63°	4500	4500	66°	4260	4260	69°	4020	4020	90	
95	61°	4300	4040	64°	4060	4060	67°	3850	3850	95	
100	59°	4100	3440	62°	3870	3870	65°	3680	3680	100	
105	57°	3900	2920	60°	3690	3530	63°	3530	3530	105	
110	54°	3600	2440	58°	3530	3000	61°	3390	3390	110	
115	52°	3300	2010	56°	3370	2530	58°	3250	2950	115	
120	49°	3000	1620	53°	3220	2100	56°	3130	2480	120	
125	47°	2590	1270	51°	2980	1700	53°	3000	2050	125	
130	44°	2220	940	48°	2610	1340	50°	2890	1650	130	
135	42°	1880		45°	2230	1010	47°	2500	1280	135	
140	39°	1560		42°	1880		44°	2110	930	140	
145	36°	1260		39°	1550		41°	1740		145	
150	33°	990		36°	1240		37°	1400		150	
155				32°	950		32°	1070		155	
160										160	
165										165	
170										170	
175										175	
180										180	

**CODES 125, 134, 143,
152, 161, 170**
EXTENDED 50' JIB

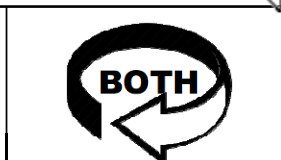
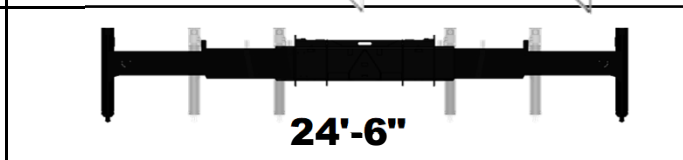
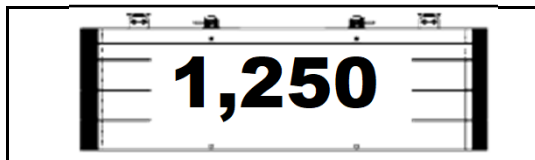
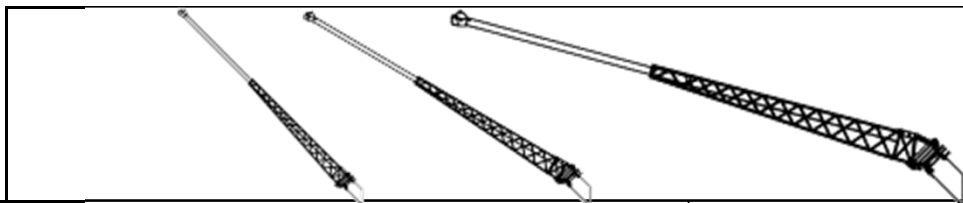

LOAD RADIUS (FT)	0° OFFSET			15° OFFSET			30° OFFSET			LOAD RADIUS (FT)
	BOOM ANGLE (DEG)	CODE 152 OVER REAR (LBS)	CODE 125 FULL 360° (LBS)	BOOM ANGLE (DEG)	CODE 161 OVER REAR (LBS)	CODE 134 FULL 360° (LBS)	BOOM ANGLE (DEG)	CODE 170 OVER REAR (LBS)	CODE 143 FULL 360° (LBS)	
25										25
30										30
35										35
40	79°	7600	7600							40
45	76°	7200	7200							45
50	75°	6900	6900	79°	6370	6370				50
55	73°	6500	6500	78°	6040	6040				55
60	72°	6200	6200	76°	5750	5750	79°	5340	5340	60
65	70°	5900	5900	75°	5460	5460	78°	5080	5080	65
70	69°	5600	5600	73°	5190	5190	76°	4840	4840	70
75	67°	5300	5300	71°	4940	4940	74°	4620	4620	75
80	66°	5000	5000	70°	4700	4700	72°	4410	4410	80
85	64°	4800	4800	68°	4470	4470	70°	4210	4210	85
90	63°	4500	4380	66°	4260	4260	69°	4020	4020	90
95	61°	4300	3740	64°	4060	4060	67°	3850	3850	95
100	59°	4100	3160	62°	3870	3820	65°	3680	3680	100
105	57°	3900	2650	60°	3690	3260	63°	3530	3530	105
110	54°	3600	2190	58°	3530	2750	61°	3390	3220	110
115	52°	3230	1770	56°	3370	2290	58°	3250	2710	115
120	49°	2800	1390	53°	3220	1870	56°	3130	2250	120
125	47°	2400	1050	51°	2820	1480	53°	3000	1830	125
130	44°	2030		48°	2420	1130	50°	2720	1440	130
135	42°	1690		45°	2050	800	47°	2310	1070	135
140	39°	1380		42°	1700		44°	1930		140
145	36°	1090		39°	1380		41°	1580		145
150	33°	830		36°	1080		37°	1240		150
155				32°	790		32°	910		155
160										160
165										165
170										170
175										175
180										180

**CODES 126, 135, 144,
153, 162, 171**
EXTENDED 50' JIB

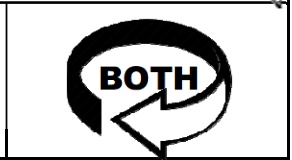
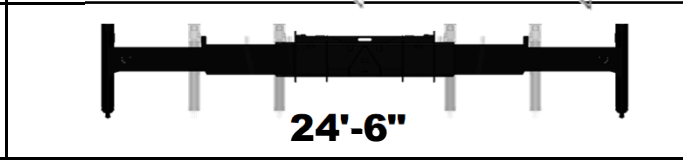
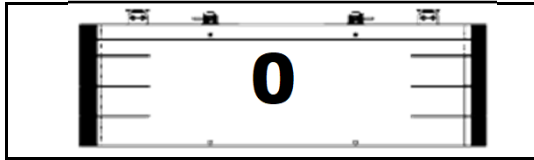
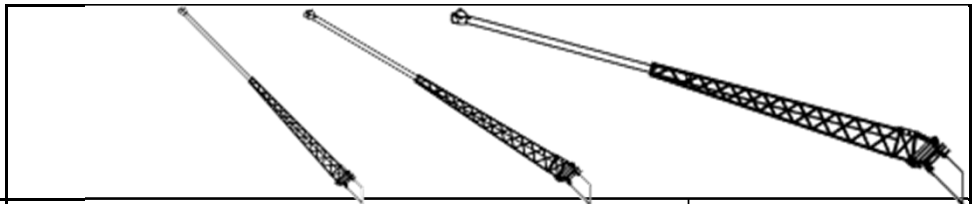

LOAD RADIUS (FT)	0° OFFSET			15° OFFSET			30° OFFSET			LOAD RADIUS (FT)
	BOOM ANGLE (DEG)	CODE 153	CODE 126	BOOM ANGLE (DEG)	CODE 162	CODE 135	BOOM ANGLE (DEG)	CODE 171	CODE 144	
		OVER REAR (LBS)	FULL 360° (LBS)		OVER REAR (LBS)	FULL 360° (LBS)		OVER REAR (LBS)	FULL 360° (LBS)	
25										25
30										30
35										35
40	79°	7600	7600							40
45	76°	7200	7200							45
50	75°	6900	6900	79°	6370	6370				50
55	73°	6500	6500	78°	6040	6040				55
60	72°	6200	6200	76°	5750	5750	79°	5340	5340	60
65	70°	5900	5900	75°	5460	5460	78°	5080	5080	65
70	69°	5600	5600	73°	5190	5190	76°	4840	4840	70
75	67°	5300	5300	71°	4940	4940	74°	4620	4620	75
80	66°	5000	5000	70°	4700	4700	72°	4410	4410	80
85	64°	4800	4780	68°	4470	4470	70°	4210	4210	85
90	63°	4500	4060	66°	4260	4260	69°	4020	4020	90
95	61°	4300	3430	64°	4060	4060	67°	3850	3850	95
100	59°	4100	2880	62°	3870	3540	65°	3680	3680	100
105	57°	3900	2380	60°	3690	2990	63°	3530	3500	105
110	54°	3490	1930	58°	3530	2490	61°	3390	2960	110
115	52°	3020	1530	56°	3370	2040	58°	3250	2470	115
120	49°	2590	1160	53°	3060	1640	56°	3130	2020	120
125	47°	2200	830	51°	2630	1260	53°	2960	1610	125
130	44°	1840		48°	2230	920	50°	2530	1220	130
135	42°	1510		45°	1870		47°	2130	870	135
140	39°	1210		42°	1530		44°	1760		140
145	36°	930		39°	1210		41°	1410		145
150				36°	920		37°	1080		150
155							32°	760		155
160										160
165										165
170										170
175										175
180										180

**CODES 172, 181, 190,
199, 208, 217**
FIXED 30' JIB

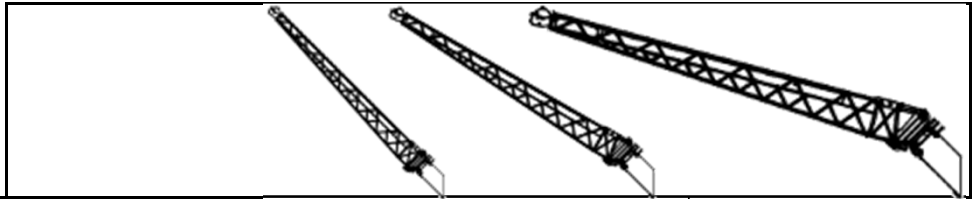

10,000

24'-6"

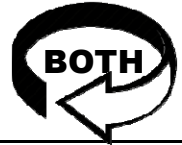

LOAD RADIUS (FT)	0° OFFSET			15° OFFSET			30° OFFSET			LOAD RADIUS (FT)
	BOOM ANGLE (DEG)	CODE 199	CODE 172	BOOM ANGLE (DEG)	CODE 208	CODE 181	BOOM ANGLE (DEG)	CODE 217	CODE 190	
		OVER REAR (LBS)	FULL 360° (LBS)		OVER REAR (LBS)	FULL 360° (LBS)		OVER REAR (LBS)	FULL 360° (LBS)	
6										6
8										8
10										10
12										12
15										15
20										20
25										25
30										30
35	79°	9000	9000							35
40	77°	9000	9000	79°	9000	9000				40
45	75°	9000	9000	78°	8580	8580				45
50	74°	8780	8780	76°	8130	8130	79°	7680	7680	50
55	72°	8520	8520	74°	7680	7680	77°	7590	7590	55
60	70°	8190	8190	73°	7260	7260	75°	7510	7510	60
65	68°	7760	7760	71°	6870	6870	73°	7160	7160	65
70	66°	7360	7360	69°	6490	6490	71°	6830	6830	70
75	64°	6840	6840	67°	6300	6300	69°	6530	6530	75
80	62°	6310	6310	65°	6280	6280	67°	6250	6250	80
85	60°	5840	5840	63°	5980	5980	65°	5980	5980	85
90	58°	5370	5370	61°	5540	5540	63°	5720	5720	90
95	55°	4940	4940	58°	5090	5090	60°	5470	5470	95
100	53°	4520	4520	56°	4670	4670	58°	5030	5030	100
105	50°	4140	4140	53°	4290	4290	55°	4610	4610	105
110	48°	3790	3590	50°	3930	3920	52°	4220	4160	110
115	45°	3450	3100	48°	3590	3390	49°	3850	3610	115
120	42°	3140	2640	45°	3280	2910	46°	3500	3100	120
125	39°	2860	2230	42°	2980	2470	43°	3170	2630	125
130	36°	2590	1860	38°	2700	2060	39°	2860	2190	130
135	32°	2340	1510	34°	2430	1690	35°	2570	1790	135
140	28°	2110	1190	30°	2170	1340	30°	2290	1410	140
145										145
150										150

**CODES 173, 182, 191,
200, 209, 218**
FIXED 30' JIB

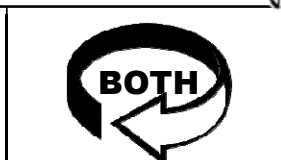
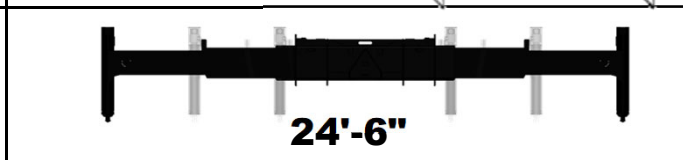
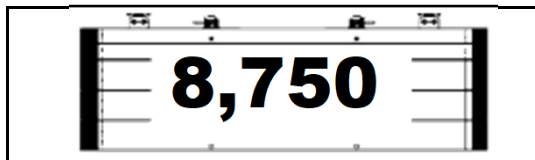
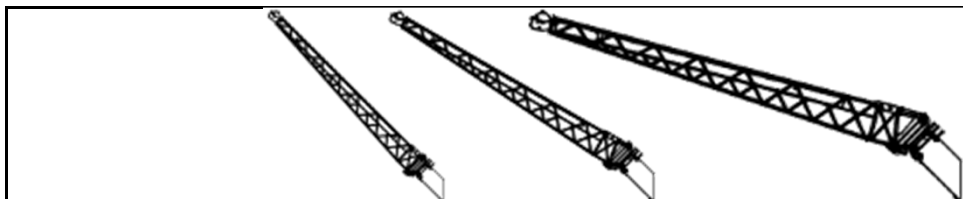

LOAD RADIUS (FT)	0° OFFSET			15° OFFSET			30° OFFSET			LOAD RADIUS (FT)
	BOOM ANGLE (DEG)	CODE 200	CODE 173	BOOM ANGLE (DEG)	CODE 209	CODE 182	BOOM ANGLE (DEG)	CODE 218	CODE 191	
		OVER REAR (LBS)	FULL 360° (LBS)		OVER REAR (LBS)	FULL 360° (LBS)		OVER REAR (LBS)	FULL 360° (LBS)	
6										6
8										8
10										10
12										12
15										15
20										20
25										25
30										30
35	79°	9000	9000							35
40	77°	9000	9000	79°	9000	9000				40
45	75°	9000	9000	78°	8580	8580				45
50	74°	8780	8780	76°	8130	8130	79°	7680	7680	50
55	72°	8520	8520	74°	7680	7680	77°	7590	7590	55
60	70°	8190	8190	73°	7260	7260	75°	7510	7510	60
65	68°	7760	7760	71°	6870	6870	73°	7160	7160	65
70	66°	7360	7360	69°	6490	6490	71°	6830	6830	70
75	64°	6840	6840	67°	6300	6300	69°	6530	6530	75
80	62°	6310	6310	65°	6280	6280	67°	6250	6250	80
85	60°	5840	5840	63°	5980	5980	65°	5980	5980	85
90	58°	5370	5370	61°	5540	5540	63°	5720	5720	90
95	55°	4940	4940	58°	5090	5090	60°	5470	5470	95
100	53°	4520	4470	56°	4670	4670	58°	5030	5030	100
105	50°	4140	3870	53°	4290	4230	55°	4610	4510	105
110	48°	3790	3340	50°	3930	3660	52°	4220	3910	110
115	45°	3450	2850	48°	3590	3150	49°	3850	3360	115
120	42°	3140	2410	45°	3280	2680	46°	3500	2860	120
125	39°	2860	2010	42°	2980	2250	43°	3170	2410	125
130	36°	2590	1650	38°	2700	1850	39°	2860	1980	130
135	32°	2340	1310	34°	2430	1490	35°	2570	1590	135
140	28°	2090	1000	30°	2170	1140	30°	2290	1210	140
145										145
150										150

**CODES 174, 183, 192,
201, 210, 219**
FIXED 30' JIB

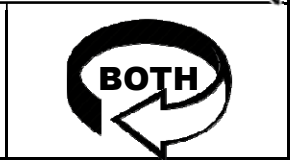
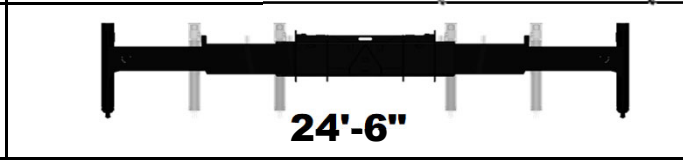
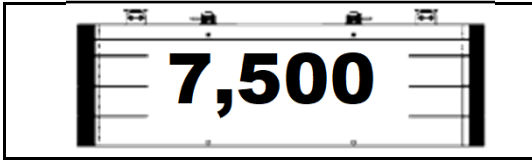
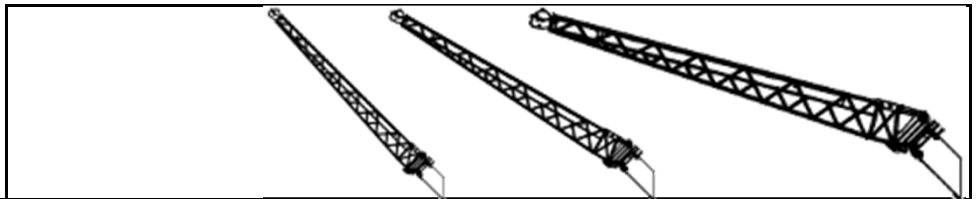

LOAD RADIUS (FT)	0° OFFSET			15° OFFSET			30° OFFSET			LOAD RADIUS (FT)
	BOOM ANGLE (DEG)	CODE 201	CODE 174	BOOM ANGLE (DEG)	CODE 210	CODE 183	BOOM ANGLE (DEG)	CODE 219	CODE 192	
		OVER REAR (LBS)	FULL 360° (LBS)		OVER REAR (LBS)	FULL 360° (LBS)		OVER REAR (LBS)	FULL 360° (LBS)	
6										6
8										8
10										10
12										12
15										15
20										20
25										25
30										30
35	79°	9000	9000							35
40	77°	9000	9000	79°	9000	9000				40
45	75°	9000	9000	78°	8580	8580				45
50	74°	8780	8780	76°	8130	8130	79°	7680	7680	50
55	72°	8520	8520	74°	7680	7680	77°	7590	7590	55
60	70°	8190	8190	73°	7260	7260	75°	7510	7510	60
65	68°	7760	7760	71°	6870	6870	73°	7160	7160	65
70	66°	7360	7360	69°	6490	6490	71°	6830	6830	70
75	64°	6840	6840	67°	6300	6300	69°	6530	6530	75
80	62°	6310	6310	65°	6280	6280	67°	6250	6250	80
85	60°	5840	5840	63°	5980	5980	65°	5980	5980	85
90	58°	5370	5370	61°	5540	5540	63°	5720	5720	90
95	55°	4940	4840	58°	5090	5090	60°	5470	5470	95
100	53°	4520	4180	56°	4670	4580	58°	5030	4890	100
105	50°	4140	3600	53°	4290	3960	55°	4610	4240	105
110	48°	3790	3080	50°	3930	3410	52°	4220	3650	110
115	45°	3450	2610	48°	3590	2900	49°	3850	3120	115
120	42°	3140	2180	45°	3280	2450	46°	3500	2630	120
125	39°	2860	1790	42°	2980	2030	43°	3170	2180	125
130	36°	2590	1430	38°	2700	1640	39°	2860	1770	130
135	32°	2260	1100	34°	2430	1280	35°	2530	1380	135
140	28°	1920		30°	2060	950	30°	2130	1020	140
145										145
150										150

**CODES 175, 184, 193,
202, 211, 220**
FIXED 30' JIB

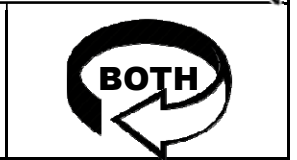
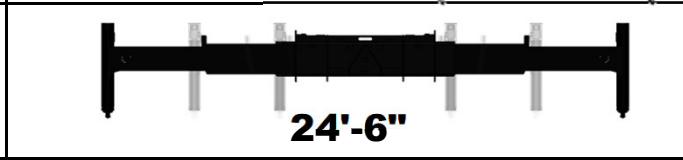
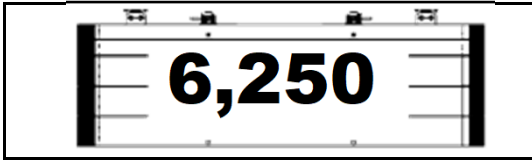
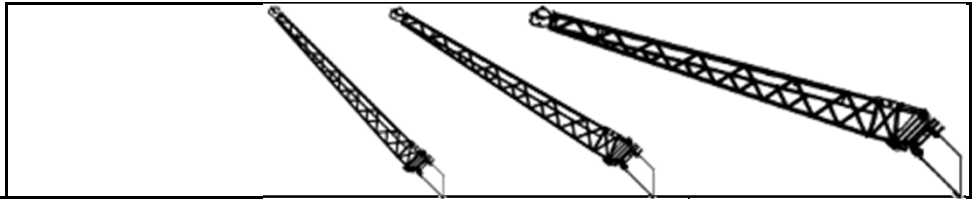

LOAD RADIUS (FT)	0° OFFSET			15° OFFSET			30° OFFSET			LOAD RADIUS (FT)
	BOOM ANGLE (DEG)	CODE 202	CODE 175	BOOM ANGLE (DEG)	CODE 211	CODE 184	BOOM ANGLE (DEG)	CODE 220	CODE 193	
		OVER REAR (LBS)	FULL 360° (LBS)		OVER REAR (LBS)	FULL 360° (LBS)		OVER REAR (LBS)	FULL 360° (LBS)	
6										6
8										8
10										10
12										12
15										15
20										20
25										25
30										30
35	79°	9000	9000							35
40	77°	9000	9000	79°	9000	9000				40
45	75°	9000	9000	78°	8580	8580				45
50	74°	8780	8780	76°	8130	8130	79°	7680	7680	50
55	72°	8520	8520	74°	7680	7680	77°	7590	7590	55
60	70°	8190	8190	73°	7260	7260	75°	7510	7510	60
65	68°	7760	7760	71°	6870	6870	73°	7160	7160	65
70	66°	7360	7360	69°	6490	6490	71°	6830	6830	70
75	64°	6840	6840	67°	6300	6300	69°	6530	6530	75
80	62°	6310	6310	65°	6280	6280	67°	6250	6250	80
85	60°	5840	5840	63°	5980	5980	65°	5980	5980	85
90	58°	5370	5250	61°	5540	5540	63°	5720	5720	90
95	55°	4940	4530	58°	5090	4970	60°	5470	5320	95
100	53°	4520	3900	56°	4670	4290	58°	5030	4610	100
105	50°	4140	3330	53°	4290	3690	55°	4610	3970	105
110	48°	3790	2830	50°	3930	3150	52°	4220	3400	110
115	45°	3450	2370	48°	3590	2660	49°	3850	2880	115
120	42°	3140	1950	45°	3280	2210	46°	3500	2400	120
125	39°	2840	1570	42°	2980	1800	43°	3170	1960	125
130	36°	2440	1220	38°	2650	1430	39°	2770	1560	130
135	32°	2080	900	34°	2250	1080	35°	2350	1180	135
140	28°	1740		30°	1890		30°	1960		140
145										145
150										150

**CODES 176, 185, 194,
203, 212, 221**
FIXED 30' JIB

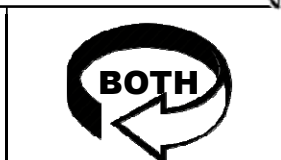
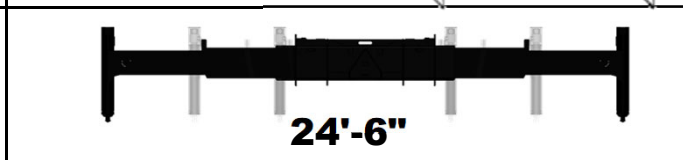
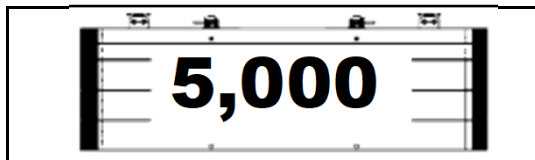
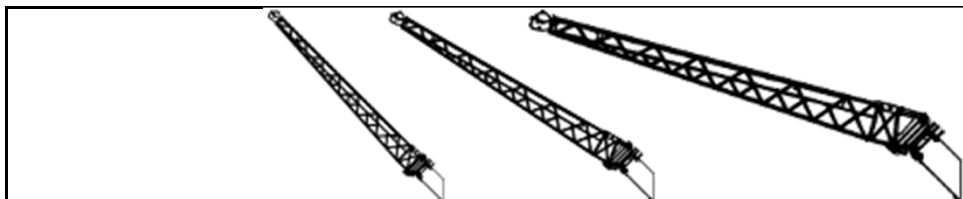

LOAD RADIUS (FT)	0° OFFSET			15° OFFSET			30° OFFSET			LOAD RADIUS (FT)
	BOOM ANGLE (DEG)	CODE 203	CODE 176	BOOM ANGLE (DEG)	CODE 212	CODE 185	BOOM ANGLE (DEG)	CODE 221	CODE 194	
		OVER REAR (LBS)	FULL 360° (LBS)		OVER REAR (LBS)	FULL 360° (LBS)		OVER REAR (LBS)	FULL 360° (LBS)	
6										6
8										8
10										10
12										12
15										15
20										20
25										25
30										30
35	79°	9000	9000							35
40	77°	9000	9000	79°	9000	9000				40
45	75°	9000	9000	78°	8580	8580				45
50	74°	8780	8780	76°	8130	8130	79°	7680	7680	50
55	72°	8520	8520	74°	7680	7680	77°	7590	7590	55
60	70°	8190	8190	73°	7260	7260	75°	7510	7510	60
65	68°	7760	7760	71°	6870	6870	73°	7160	7160	65
70	66°	7360	7360	69°	6490	6490	71°	6830	6830	70
75	64°	6840	6840	67°	6300	6300	69°	6530	6530	75
80	62°	6310	6310	65°	6280	6280	67°	6250	6250	80
85	60°	5840	5720	63°	5980	5980	65°	5980	5980	85
90	58°	5370	4930	61°	5540	5400	63°	5720	5720	90
95	55°	4940	4230	58°	5090	4670	60°	5470	5020	95
100	53°	4520	3620	56°	4670	4010	58°	5030	4320	100
105	50°	4140	3060	53°	4290	3420	55°	4610	3700	105
110	48°	3790	2570	50°	3930	2900	52°	4220	3140	110
115	45°	3450	2120	48°	3590	2420	49°	3850	2630	115
120	42°	3060	1720	45°	3280	1980	46°	3500	2170	120
125	39°	2640	1350	42°	2870	1580	43°	3030	1740	125
130	36°	2250	1010	38°	2460	1220	39°	2580	1350	130
135	32°	1900		34°	2070	880	35°	2170	980	135
140	28°	1570		30°	1710		30°	1780		140
145										145
150										150

**CODES 177, 186, 195,
204, 213, 222**
FIXED 30' JIB

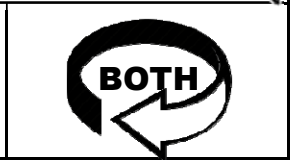
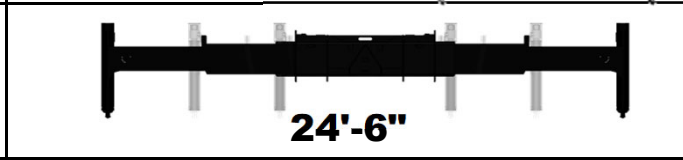
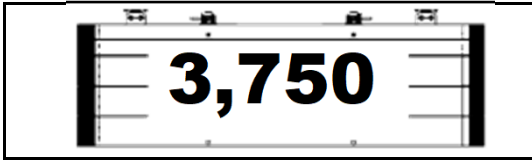
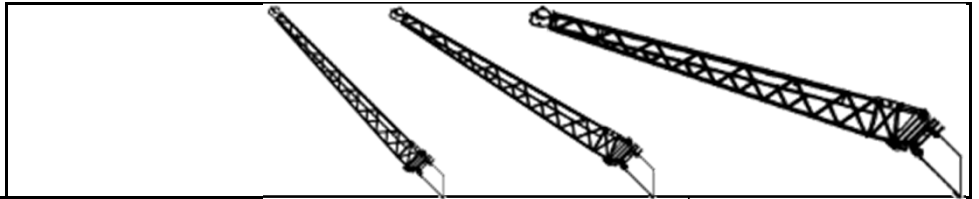

LOAD RADIUS (FT)	0° OFFSET			15° OFFSET			30° OFFSET			LOAD RADIUS (FT)
	BOOM ANGLE (DEG)	CODE 204	CODE 177	BOOM ANGLE (DEG)	CODE 213	CODE 186	BOOM ANGLE (DEG)	CODE 222	CODE 195	
		OVER REAR (LBS)	FULL 360° (LBS)		OVER REAR (LBS)	FULL 360° (LBS)		OVER REAR (LBS)	FULL 360° (LBS)	
6										6
8										8
10										10
12										12
15										15
20										20
25										25
30										30
35	79°	9000	9000							35
40	77°	9000	9000	79°	9000	9000				40
45	75°	9000	9000	78°	8580	8580				45
50	74°	8780	8780	76°	8130	8130	79°	7680	7680	50
55	72°	8520	8520	74°	7680	7680	77°	7590	7590	55
60	70°	8190	8190	73°	7260	7260	75°	7510	7510	60
65	68°	7760	7760	71°	6870	6870	73°	7160	7160	65
70	66°	7360	7360	69°	6490	6490	71°	6830	6830	70
75	64°	6840	6840	67°	6300	6300	69°	6530	6530	75
80	62°	6310	6260	65°	6280	6280	67°	6250	6250	80
85	60°	5840	5380	63°	5980	5900	65°	5980	5980	85
90	58°	5370	4610	61°	5540	5080	63°	5720	5470	90
95	55°	4940	3930	58°	5090	4360	60°	5470	4720	95
100	53°	4520	3330	56°	4670	3730	58°	5030	4040	100
105	50°	4140	2800	53°	4290	3150	55°	4610	3430	105
110	48°	3790	2310	50°	3930	2640	52°	4220	2890	110
115	45°	3310	1880	48°	3590	2170	49°	3810	2390	115
120	42°	2860	1490	45°	3120	1750	46°	3300	1940	120
125	39°	2440	1130	42°	2670	1360	43°	2830	1520	125
130	36°	2070		38°	2270	1000	39°	2400	1130	130
135	32°	1720		34°	1890		35°	1990		135
140	28°	1390		30°	1540		30°	1610		140
145										145
150										150

**CODES 178, 187, 196,
205, 214, 223**

FIXED 30' JIB

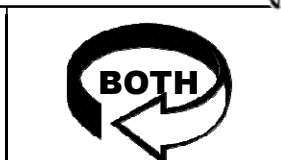
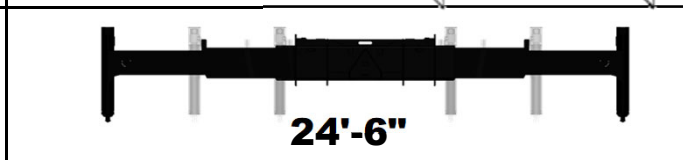
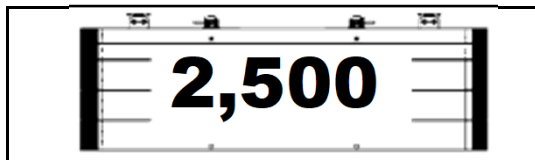
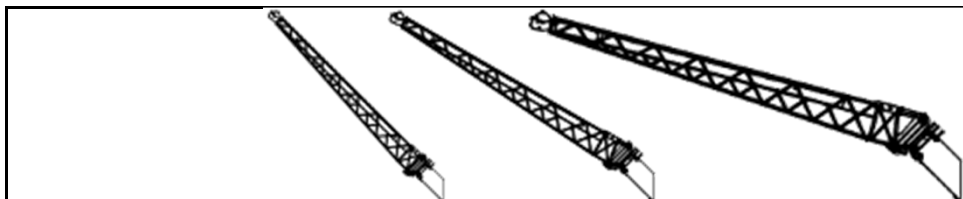

LOAD RADIUS (FT)	0° OFFSET			15° OFFSET			30° OFFSET			LOAD RADIUS (FT)
	BOOM ANGLE (DEG)	CODE 205	CODE 178	BOOM ANGLE (DEG)	CODE 214	CODE 187	BOOM ANGLE (DEG)	CODE 223	CODE 196	
		OVER REAR (LBS)	FULL 360° (LBS)		OVER REAR (LBS)	FULL 360° (LBS)		OVER REAR (LBS)	FULL 360° (LBS)	
6										6
8										8
10										10
12										12
15										15
20										20
25										25
30										30
35	79°	9000	9000							35
40	77°	9000	9000	79°	9000	9000				40
45	75°	9000	9000	78°	8580	8580				45
50	74°	8780	8780	76°	8130	8130	79°	7680	7680	50
55	72°	8520	8520	74°	7680	7680	77°	7590	7590	55
60	70°	8190	8190	73°	7260	7260	75°	7510	7510	60
65	68°	7760	7760	71°	6870	6870	73°	7160	7160	65
70	66°	7360	7360	69°	6490	6490	71°	6830	6830	70
75	64°	6840	6840	67°	6300	6300	69°	6530	6530	75
80	62°	6310	5890	65°	6280	6280	67°	6250	6250	80
85	60°	5840	5030	63°	5980	5560	65°	5980	5980	85
90	58°	5370	4290	61°	5540	4760	63°	5720	5150	90
95	55°	4940	3630	58°	5090	4060	60°	5470	4410	95
100	53°	4520	3050	56°	4670	3440	58°	5030	3760	100
105	50°	4110	2530	53°	4290	2890	55°	4610	3170	105
110	48°	3580	2060	50°	3900	2390	52°	4140	2630	110
115	45°	3090	1640	48°	3380	1930	49°	3590	2150	115
120	42°	2650	1250	45°	2910	1520	46°	3090	1710	120
125	39°	2250	910	42°	2480	1140	43°	2630	1300	125
130	36°	1880		38°	2080		39°	2210	920	130
135	32°	1540		34°	1710		35°	1810		135
140	28°	1220		30°	1370		30°	1430		140
145										145
150										150

**CODES 179, 188, 197,
206, 215, 224**
FIXED 30' JIB

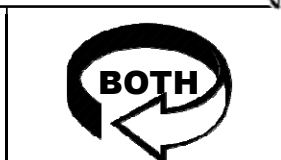
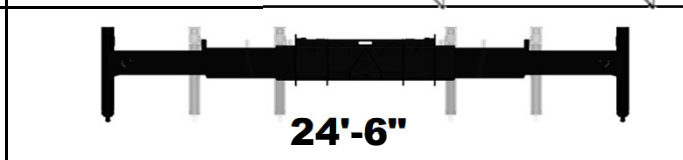
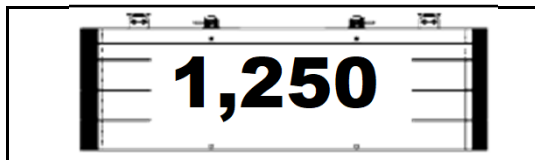
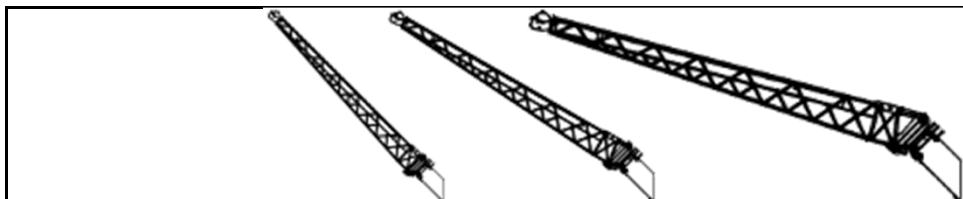

LOAD RADIUS (FT)	0° OFFSET			15° OFFSET			30° OFFSET			LOAD RADIUS (FT)
	BOOM ANGLE (DEG)	CODE 206	CODE 179	BOOM ANGLE (DEG)	CODE 215	CODE 188	BOOM ANGLE (DEG)	CODE 224	CODE 197	
		OVER REAR (LBS)	FULL 360° (LBS)		OVER REAR (LBS)	FULL 360° (LBS)		OVER REAR (LBS)	FULL 360° (LBS)	
6										6
8										8
10										10
12										12
15										15
20										20
25										25
30										30
35	79°	9000	9000							35
40	77°	9000	9000	79°	9000	9000				40
45	75°	9000	9000	78°	8580	8580				45
50	74°	8780	8780	76°	8130	8130	79°	7680	7680	50
55	72°	8520	8520	74°	7680	7680	77°	7590	7590	55
60	70°	8190	8190	73°	7260	7260	75°	7510	7510	60
65	68°	7760	7760	71°	6870	6870	73°	7160	7160	65
70	66°	7360	7360	69°	6490	6490	71°	6830	6830	70
75	64°	6840	6480	67°	6300	6300	69°	6530	6530	75
80	62°	6310	5520	65°	6280	6100	67°	6250	6250	80
85	60°	5840	4690	63°	5980	5210	65°	5980	5650	85
90	58°	5370	3960	61°	5540	4440	63°	5720	4830	90
95	55°	4940	3330	58°	5090	3760	60°	5470	4110	95
100	53°	4460	2760	56°	4670	3160	58°	5030	3470	100
105	50°	3870	2260	53°	4230	2620	55°	4500	2900	105
110	48°	3350	1800	50°	3670	2130	52°	3910	2380	110
115	45°	2880	1390	48°	3160	1690	49°	3380	1910	115
120	42°	2450	1020	45°	2700	1290	46°	2890	1470	120
125	39°	2050		42°	2280	920	43°	2440	1080	125
130	36°	1690		38°	1890		39°	2020		130
135	32°	1360		34°	1530		35°	1630		135
140	28°	1050		30°	1190		30°	1260		140
145										145
150										150

**CODES 180, 189, 198,
207, 216, 225**
FIXED 30' JIB

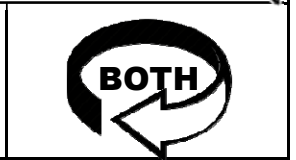
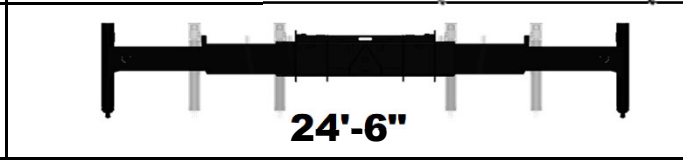
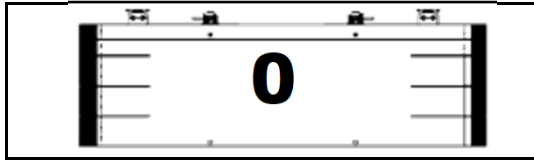
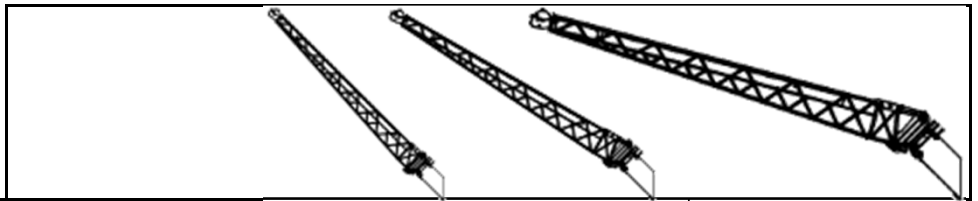

LOAD RADIUS (FT)	0° OFFSET			15° OFFSET			30° OFFSET			LOAD RADIUS (FT)
	BOOM ANGLE (DEG)	CODE 207	CODE 180	BOOM ANGLE (DEG)	CODE 216	CODE 189	BOOM ANGLE (DEG)	CODE 225	CODE 198	
		OVER REAR (LBS)	FULL 360° (LBS)		OVER REAR (LBS)	FULL 360° (LBS)		OVER REAR (LBS)	FULL 360° (LBS)	
6										6
8										8
10										10
12										12
15										15
20										20
25										25
30										30
35	79°	9000	9000							35
40	77°	9000	9000	79°	9000	9000				40
45	75°	9000	9000	78°	8580	8580				45
50	74°	8780	8780	76°	8130	8130	79°	7680	7680	50
55	72°	8520	8520	74°	7680	7680	77°	7590	7590	55
60	70°	8190	8190	73°	7260	7260	75°	7510	7510	60
65	68°	7760	7760	71°	6870	6870	73°	7160	7160	65
70	66°	7360	7180	69°	6490	6490	71°	6830	6830	70
75	64°	6840	6090	67°	6300	6300	69°	6530	6530	75
80	62°	6310	5150	65°	6280	5730	67°	6250	6220	80
85	60°	5840	4350	63°	5980	4870	65°	5980	5310	85
90	58°	5370	3640	61°	5540	4120	63°	5720	4510	90
95	55°	4840	3020	58°	5090	3460	60°	5470	3810	95
100	53°	4210	2480	56°	4590	2870	58°	4900	3190	100
105	50°	3640	1990	53°	3990	2350	55°	4260	2630	105
110	48°	3120	1550	50°	3440	1870	52°	3680	2120	110
115	45°	2660	1150	48°	2950	1450	49°	3160	1660	115
120	42°	2240		45°	2500	1060	46°	2680	1240	120
125	39°	1850		42°	2080		43°	2240	860	125
130	36°	1500		38°	1700		39°	1830		130
135	32°	1170		34°	1350		35°	1450		135
140	28°	870		30°	1020		30°	1090		140
145										145
150										150